

**SYSTXCCITC01-B, SYSTXCCWIC01-B,
SYSTXCCICF01-B, SYSTXCCWIF01-B
Infinity® System Control**

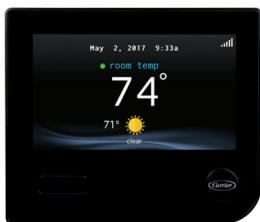

Turn to the experts

Installation Instructions



A170203



A180218C

NOTE: Read the entire instruction manual before starting the installation.

NOTE: Please refer to the literature provided with the connected HVAC equipment for more details on system operations with specific pieces of equipment.

The features and functions outlined in the Installation Instructions reflect Version 1.3 or later software. Occupancy sensing compatibility is only available with Series B Infinity System Controls. See the Infinity System Control product page on the HVACPartners.com website or the Downloads section of the www.MyInfinityTouch.Carrier.com website for the latest software release and literature.

US Patents: Carrier U.S. Pat No. 7,243,004, U.S. Pat No. 7,775,452, pointSET™ U.S. Pat No. 7,415,102

Table of Contents

| Page | |
|----------|--|
| 1. | Safety Considerations 6 |
| 2. | Introduction 6 |
| 3. | Quick Start 7 |
| 3.1. | Set Time and Date 7 |
| 3.1.1. | Manually Adjust Time and Date 7 |
| 3.1.2. | Setup Time Zone 7 |
| 3.1.3. | Enable Time Synchronization 7 |
| 3.2. | Set Dealer Information 8 |
| 4. | Installation 8 |
| 4.1. | Overview 8 |
| 4.2. | Check Equipment 9 |
| 4.3. | Location 9 |
| 4.3.1. | Wall Control 9 |
| 4.3.2. | Wired Remote Room Sensors 10 |
| 4.3.2.1. | Wired Remote Room Sensor Averaging 10 |
| 4.3.3. | Smart Sensors (for zoning applications) 10 |
| 4.4. | Wiring Considerations 11 |
| 4.4.1. | Shielded Wire and Communication Bus Configuration 11 |
| 4.4.2. | Damper Control Module (zoning systems only) 12 |
| 4.5. | Decorative Trim Plate 13 |
| 4.5.1. | Mounting 13 |
| 4.5.2. | System Control Mounting 13 |
| 4.6. | Humidifier Connections 14 |
| 4.6.1. | Bypass Humidifier 14 |
| 4.6.2. | Fan Powered Humidifiers 14 |
| 5. | Commissioning 15 |
| 5.1. | Searching for Indoor Unit 15 |
| 5.2. | Searching for Outdoor Unit 15 |
| 5.3. | Indoor Evaporator Selection 16 |
| 5.4. | Electric Heater Selection 16 |
| 5.4.1. | Hydronic Heat Application 17 |
| 5.5. | Searching for SAM Module (If Applicable) 17 |
| 5.6. | Searching for Zones (If Applicable) 18 |
| 5.7. | Filter Type Selection 18 |
| 5.8. | Humidifier Installation 18 |
| 5.9. | Ultraviolet Lights Installation 19 |
| 5.10. | Equipment Summary 19 |
| 5.11. | Airflow Verification Check 19 |
| 5.12. | Duct Assessment (zoned systems only) 20 |
| 6. | Service Menu 20 |
| 6.1. | Equipment Summary 21 |

| | | |
|-----------|--|----|
| 6.2. | Installation | 21 |
| 6.3. | Set up | 22 |
| 6.3.1. | Thermostat | 23 |
| 6.3.1.1. | Auto Mode Set Up | 23 |
| 6.3.1.2. | Heat/Cool Deadband | 23 |
| 6.3.1.3. | Offsets | 24 |
| 6.3.1.4. | Reset Factory Defaults | 24 |
| 6.3.1.5. | Scheduling On/Off | 25 |
| 6.3.1.6. | Smart Recovery On/Off | 25 |
| 6.3.2. | Fan Coil | 25 |
| 6.3.2.1. | Airflow | 25 |
| 6.3.2.2. | Altitude | 26 |
| 6.3.2.3. | Dehumidification Options | 26 |
| 6.3.2.4. | Fan Coil G-Terminal Input | 26 |
| 6.3.2.5. | Fan Coil G-Terminal Alert | 27 |
| 6.3.2.6. | Fan Coil G Terminal Alert Label | 27 |
| 6.3.3. | Furnace | 28 |
| 6.3.3.1. | Furnace Airflow | 28 |
| 6.3.3.2. | AC/HP Airflow | 28 |
| 6.3.3.3. | Furnace Staging | 29 |
| 6.3.3.4. | Furnace Airflow Limits (modulating furnace only) | 29 |
| 6.3.3.5. | Furnace Off Delay | 29 |
| 6.3.3.6. | Altitude | 29 |
| 6.3.3.7. | Furnace Dehumidifier Drain | 30 |
| 6.3.3.8. | Furnace G Terminal | 30 |
| 6.3.3.9. | Furnace G-Terminal Alert | 30 |
| 6.3.3.10. | Furnace G Terminal Alert Label | 31 |
| 6.3.4. | AC/Heat Pump | 31 |
| 6.3.4.1. | Latching | 31 |
| 6.3.4.2. | Cooling Lockout | 32 |
| 6.3.4.3. | Defrost Interval | 32 |
| 6.3.4.4. | Low Ambient Cooling | 32 |
| 6.3.4.5. | Quiet Shift | 33 |
| 6.3.4.6. | AC/Heat Pump RPM Max | 33 |
| 6.3.4.7. | Defrost Fan Delay | 33 |
| 6.3.4.8. | Brownout Disable | 33 |
| 6.3.4.9. | Low Air Multiplier | 33 |
| 6.3.4.10. | Energy Efficiency | 33 |
| 6.3.5. | Heat Source Lockout | 33 |
| 6.3.6. | Stages / Latch for 18VS | 34 |
| 6.3.7. | Geothermal HP (when available) | 34 |
| 6.3.7.1. | Freeze Limits | 35 |
| 6.3.7.2. | Lockout Count | 35 |
| 6.3.7.3. | Brownout Override | 36 |
| 6.3.7.4. | Geothermal HP Energy Tracking | 36 |
| 6.3.8. | Zoning (If Applicable) | 36 |
| 6.3.8.1. | Disable Zoning | 37 |

| | | |
|----------|--|----|
| 6.3.8.2. | Zone Offsets | 37 |
| 6.3.8.3. | Airflow Limits | 37 |
| 6.3.8.4. | Duct Assessment Time | 37 |
| 6.3.9. | Accessories | 38 |
| 6.3.9.1. | Filter | 38 |
| 6.3.9.2. | Humidifier | 38 |
| 6.3.9.3. | Ultraviolet Lights | 38 |
| 6.3.9.4. | Ventilator | 39 |
| 6.3.10. | Utility Curtailment | 39 |
| 6.3.11. | Hydronic Airflow | 39 |
| 6.4. | Check out | 40 |
| 6.4.1. | Electric Heat | 41 |
| 6.4.2. | Furnace | 41 |
| 6.4.3. | Hydronic | 41 |
| 6.4.4. | Air Conditioning | 41 |
| 6.4.5. | Heat Pump Heating | 42 |
| 6.4.6. | Heat Pump Cooling | 42 |
| 6.4.7. | Humidifier | 42 |
| 6.4.8. | Ventilator | 43 |
| 6.4.9. | Zoning (If Applicable) | 43 |
| 6.4.9.1. | Airflow Limits | 43 |
| 6.4.9.2. | Damper/Sensor Check | 43 |
| 6.4.9.3. | Zone Duct Assessment | 44 |
| 6.4.9.4. | Sensor Type | 44 |
| 6.5. | Service Information | 44 |
| 6.5.1. | Advanced Diagnostics | 44 |
| 6.5.2. | Fan Coil Status | 44 |
| 6.5.3. | Furnace Status | 45 |
| 6.5.4. | AC Status | 45 |
| 6.5.5. | Heat Pump Status | 45 |
| 6.5.6. | Geothermal HP Status | 46 |
| 6.5.7. | Zoning Status | 46 |
| 6.5.8. | Last 10 System Events | 46 |
| 6.5.9. | Run/Fault History | 47 |
| 6.5.10. | Model/Serial Numbers | 47 |
| 6.5.11. | Service Phone Number | 47 |
| 6.5.12. | Energy Tracking | 48 |
| 6.6. | Refrigerant Charging: Greenspeed® Intelligence, 18VS™, 19VS™ Systems | 48 |
| 6.6.1. | Charging | 48 |
| 6.6.2. | Pump Down | 49 |
| 6.6.3. | Evacuation | 50 |
| 6.6.4. | EXV Position | 50 |
| 6.7. | Dealer Logo | 50 |
| 6.8. | Utility Event Setup | 51 |
| 7. | Wireless Set-up | 51 |
| 7.1. | Setup and Status Information (Homeowner's Router) | 52 |

| | |
|---|----|
| 8. Wiring Diagrams | 56 |
| 9. Statement Information | 65 |
| 9.1. FCC Interference Statement | 65 |

NOTE: See the Owner's Manual for information regarding software upgrades.

1. Safety Considerations

Improper installation, adjustment, alteration, service, maintenance, or use can cause explosion, fire, electrical shock, or other conditions which may cause death, personal injury or property damage. Consult a qualified installer, service agency or your distributor or branch for information or assistance. The qualified installer or agency must use factory-authorized kits or accessories when modifying this HVAC system. Refer to the individual instructions packaged with the kits or accessories when installing.

Follow all safety codes. Wear safety glasses, protective clothing, and work gloves. Have a fire extinguisher available. Read these instructions thoroughly and follow all warnings and cautions included in literature and attached to the unit. Consult local building codes and the current edition of the National Electrical Code (NEC) NFPA 70. In Canada, refer to the current editions of the Canadian Electrical Code CSA C22.1.

Recognize safety information. When you see this symbol  on the unit and in instructions or manuals, be alert to the potential for personal injury. Understand the signal words DANGER, WARNING, and CAUTION. These words are used with the safety-alert symbol. DANGER identifies the most serious hazards, which will result in severe personal injury or death. WARNING signifies hazards, which could result in personal injury or death. CAUTION is used to identify unsafe practices, which may result in minor personal injury or product and property damage. NOTE is used to highlight suggestions which will result in enhanced installation, reliability, or operation.

2. Introduction

The Infinity® System consists of several intelligent communicating components which include the Infinity System Control (or User Interface), variable speed furnace or FE fan coil, 2-stage AC and HP, (including Geothermal units), multi-stage AC and HP, variable capacity HP and AC units, and Infinity System Package units which continually communicate with each other via a four-wire connection called the ABCD bus. Commands, operating conditions, and other data are passed continually between components over the ABCD bus. The result is a new level of comfort, versatility, and simplicity.

All Infinity System furnaces or fan coils are variable-speed and multi stage for maximum flexibility, efficiency, and comfort. They support controlled ventilation, humidification, dehumidification, and air quality control. Either an Infinity System (communicating), or a standard single-stage 24VAC controlled outdoor unit may be used.

When using conventional single-stage outdoor units, the Infinity System furnace or fan coil provides the 24 volt signals needed to control them. When using multi-stage conventional outdoor units or heat pumps, an Infinity System Network Interface Module or “NIM” (P/N

SYSTXCCNIM01) may be required to provide additional control outputs. Also, the NIM allows connection of a Carrier HRV or ERV without the need for separate wall control.

When using a Carrier HRV or ERV with a zoned system, the Infinity System Zone board allows connection of a Carrier HRV or ERV without the need for separate wall control or NIM.

All system components are controlled through the wall mounted Infinity System System Control, which replaces the conventional thermostat and provides the homeowner with a single wall control for all features of the system.

3. Quick Start

NOTE: See Installation Section for installation instructions.

3.1. Set Time and Date

The time and date can either be set manually or can be synchronized with the web server. From the main screen, touch **MENU**, on the bottom of the control. The **TIME/DATE** icon will bring up the time and date menu.

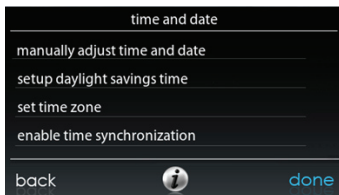

A14215

3.1.1. Manually Adjust Time and Date

- To set the **HOURL**, **MINUTE**, **MONTH**, **DAY**, or **YEAR** touch the feature you wish to change.
- Use the Up (▲) and Down (▼) buttons to make the appropriate changes.
- When you have completed all of the settings touch **SAVE**.

3.1.2. Setup Time Zone

The time zone can be selected by selecting the set time zone from the menu. Then select the time zone for the location. Time zones for both US and Canada are included.

3.1.3. Enable Time Synchronization

After setting up the time zone, the time synchronization can then be done, after connection to the Internet server. Both setting the time zone and enabling time synchronization must be done in order to enable time synchronization.

3.2. Set Dealer Information

From the main screen, touch **MENU**, on the bottom of the control, then Down (▼) button so that the **SERVICE** icon is shown. The **SERVICE** icon allows you to upload your contact information into the Infinity System Control.

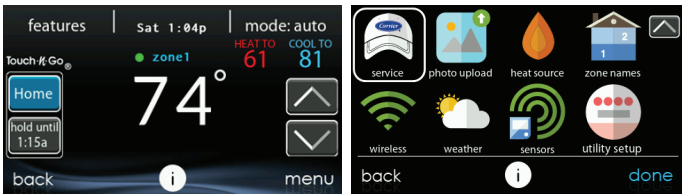

A170243C

- Format your contact information and logo (if applicable) using the PC/MAC Desktop application available at www.MyInfinityTouch.Carrier.com/Infinity/Downloads, and save it to a standard micro SD card. See Dealer Logo Section for more information.
- Touch the **SERVICE** icon for about 10 seconds, touch **DEALER LOGO UPLOAD**.
- Place the micro SD card into the micro SD card slot on the bottom of the Infinity System Control and follow the on screen prompts.
- More detailed information can be found on HVACPartners.com under: Products and Dashboards > Product Catalog > Residential Controls > Systems Controls > SYSTXCCITC01-B> Documents > Marketing > Miscellaneous> Infinity System Control Dealer Logo Application - Instructions.

4. Installation

4.1. Overview

This instruction covers installation of the Infinity System Control only. Physical installation instructions for the indoor and outdoor equipment, and accessories are provided with each unit. Setup, commissioning, operation, and troubleshooting of the Infinity System are covered in this installation instruction at a high level. More detailed information may be available in the Infinity System HVAC equipment Installation Instructions. This is the guide to connecting the system components and commissioning the system once all physical components are installed. Special screen prompts and start-up capabilities are provided in the Infinity System to simplify and automate the initial commissioning of the system.

- Install the Infinity System Control according to this instruction.
- Install indoor unit, outdoor unit, and accessories according to their instructions.

- Wire complete system according to this instruction.
- Setup, commission, and operate system according to this instruction, and as supplemented in the HVAC equipment Installation Instructions, to assure a smooth and trouble free start-up.
- Note that some detailed equipment configuration and service information may be included with the equipment instructions. Please refer to the equipment installation instruction manuals, and applicable technical training materials, for all devices for complete information.

4.2. Check Equipment

Inspect equipment. File a claim with shipping company prior to installation if shipment is damaged or incomplete.

4.3. Location



ELECTRICAL OPERATION HAZARD

Failure to follow this warning could result in personal injury or death.

Disconnect power before routing control wiring.

All wiring must comply with national, state, and local codes.

4.3.1. Wall Control

The Infinity System Control is the command center for the Infinity System. It should be located where it is easily accessible and visible to the adult homeowner or end user. For accurate temperature measurement, the following guidelines should be followed:

The Infinity System Control, Remote Room Sensors and Smart Sensors **SHOULD** be mounted:

- Approximately 5-ft (1.5 m) from the floor.
- Close to or in a frequently used room, preferably on an inside partitioning wall.
- On a section of wall without pipes or ductwork.

The Infinity System Control and Sensors **SHOULD NOT** be mounted:

- Close to a window, on an outside wall, or next to a door leading to the outside.
- Exposed to direct light or heat from a lamp, sun, fireplace, or other temperature-radiating objects which could cause a false reading.
- Close to or in direct airflow from supply registers.
- In areas with poor air circulation, such as behind a door or in an alcove.

4.3.2. Wired Remote Room Sensors

A Remote Room Sensor can be used with the Infinity System Control to take the place of the control's internal temperature sensor. This allows the Infinity System Control to be mounted in areas with less than optimal airflow (such as near an exterior door, window or in a closet). The remote sensor can be wired to the terminal block connectors labeled S1 and S2 at the control's backplate, or the ZS1 and ZS1C connection at the Damper Control Module. In either case, the Infinity System Control will automatically detect the Remote Room Sensor and ignore its internal temperature sensor.

NOTE: Humidity sensing will occur ONLY at the Infinity System Control. The wired Remote Room Sensor does NOT have humidity sensing capability.

4.3.2.1. Wired Remote Room Sensor Averaging

Typically, one wired remote sensor is used but, multiple wired sensors may be used and averaged in some applications. Averaging requires a special series-parallel wiring method with a specific number of sensors. See figure below. It is also important to note the humidity sensor cannot be remotely located, so do not locate the Infinity System Control in an area where humidity sensing may not be accurate.

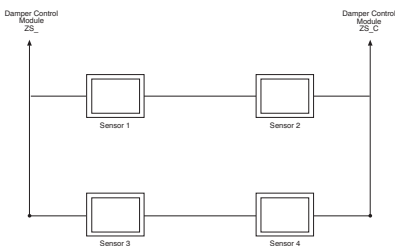

A03233

4.3.3. Smart Sensors (for zoning applications)

Any zone may use a Smart Zone Sensor (SYSTXCCSMS01). It provides a temperature display and buttons to adjust the desired temperature in that zone only. It also displays outdoor temperature and indoor humidity sensed at the Zone 1 Infinity System Control. Only one Smart Sensor may be used per zone. They cannot be averaged like Remote Room Sensors. If a Smart Sensor is used in a zone, one wired Remote Room Sensor may also be used in the same zone. The wired Remote Room Sensor has priority over the Smart Sensor; the Smart Sensor will display the wired Remote Room Sensor temperature, when used.

NOTE: Smart Sensors must be addressed to identify which zone it will control. See Smart Sensor Installation Instructions for details.

4.4. Wiring Considerations

Ordinary thermostat wire is recommended. See *Shielded Wire and Communication Bus Configuration* Section for notes on shielded wire. Continuous wire lengths over 25 ft. should use 18 AWG wiring.

NOTE: ABCD bus wiring only requires a four-wire connection; however, it is good practice to run thermostat cable having more than four wires in the event of a damaged or broken wire during installation.

Each communicating device in the Infinity Zone System has a four-pin connector labeled ABCD. It is recommended that the following color code be used when wiring each device:

A — Green = Data A+

B — Yellow = Data B-

C — White = 24VAC (Com)

D — Red = 24VAC (Hot)

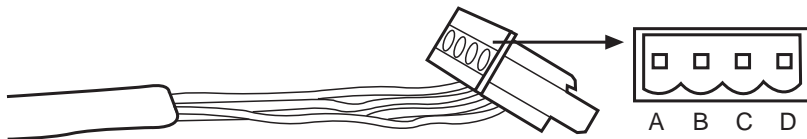

A03193

It is not mandatory that the above color code be used, but each ABCD connector in the system **MUST** be wired consistently.

NOTE: Some outdoor units, typically those with multiple compressor stages, provide their own low-voltage power source and do not require the “C” (24VAC common) and “D” (24VAC power) connections. See the outdoor unit installation instructions for more information.



WARNING

ELECTRICAL OPERATION HAZARD

Failure to follow this warning could result in personal injury or death.

Before installing, modifying, or servicing system, the main electrical disconnect switch must be in the OFF position. There may be more than one disconnect switch. Lock out and tag switch with a suitable warning label.

4.4.1. Shielded Wire and Communication Bus Configuration

If the thermostat wiring will be located near or in parallel with high voltage wiring, radio, TV or Ethernet wiring, then four conductor, twisted-pair, shielded cable can be used to reduce or

eliminate potential interference. The shield wire should be connected to the C terminal, or ground, AT THE INDOOR UNIT, ONLY. The shield wire should NOT be connected to any terminal at the Infinity System Control. Connecting the shield to ground at both ends can cause current loops in the shield, reducing shield effectiveness.

Connect one pair of the two-pair (minimum) cable to the A and B communication terminals, and another pair to the C and D terminals at both ends of the cable. The shield wire should ONLY be connected at the indoor equipment ground or C terminal. Note that some outdoor units only require the A and B connections. See the outdoor unit installation instructions for more information.

”Daisy chain” wiring, where each communicating component is wired one after another, rather than all components connecting in a “star” fashion to one point, is preferred. For wiring runs over 100 feet, terminating with a 100 ohm resistor at each end of the chain can help to avoid or mitigate electrical noise problems.

4.4.2. Damper Control Module (zoning systems only)

When used, all wiring is run back to the Infinity System Damper Control Module (SYSTXCC4ZC01). Select a location near the furnace or fan coil where wiring from the control, each Remote Room Sensor or Smart (Zone) Sensor, each damper actuator, and the equipment itself can come together easily. The Damper Control Module is approved for indoor use only and should never be installed with any of its components exposed to the elements. The Damper Control Module (and zone dampers) may be installed in any area where the temperature remains between -4°F to 158°F (-20°C to 70°C), and there is no condensation. The cover must be installed to prevent damage from other sources. Do not locate where it will be accessible to children. It may be mounted in either vertical or horizontal position. Remember that wiring access is likely the most important consideration.



CAUTION

PERSONAL INJURY HAZARD

Failure to follow this caution may result in personal injury.

To prevent possible damage to the Damper Control Module, DO NOT mount on plenum, ductwork, or flush against furnace or fan coil.

4.5. Decorative Trim Plate

Sold separately, a thin decorative trim plate is available to hide any marks/screw holes left from the previous thermostat. The trim plate is captured between the backplate and the system control. Align the trim plate around the backplate, and snap on the system control.

NOTE: Once the Infinity System Control is secured to wall with the backplate assembly (snapped together), care must be taken not to bend or break the interlocking tabs when removing.

4.5.1. Mounting

First become familiar with all plastic assembly pieces shown on the following page. The Infinity System Control will snap together with the standard backplate supplied with the wall control. Attach backplate using only a small hole in the wall allowing a four wire connection to pass through. Mount the front assembly to the standard backplate. The figure below shows the optional decorative trim plate, described in the Decorative Trim Plate Section, installed with the standard backplate. The decorative trim plate is captured between the backplate and the system control. Align the decorative trim plate around the backplate, and snap on the system control.

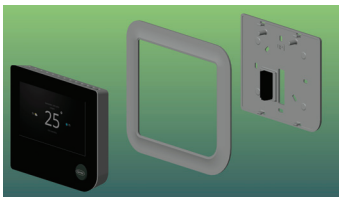

A170245C

4.5.2. System Control Mounting

- Turn off all power to equipment.
- If an existing Infinity Control or other control is being replaced:
 - Remove existing control from wall.
 - Disconnect wires from existing control.
 - Discard or recycle old control.

NOTE: Mercury is a hazardous waste, if existing control contains any mercury, it **MUST** be disposed of properly. The Infinity Control does not contain mercury.

- Select the appropriate Infinity System Control mounting configuration. Use the standard backplate (mounting plate) provided with the wall control, or add the decorative trim plate in addition to the standard backplate if desired. See the Decorative Trim Plate Section for more detail.

- Route wires through large hole in mounting plastic. The hole may be enlarged, if required, to accommodate existing installations; avoid opening the wire hole more than necessary. Level backplate against wall (for aesthetic value only; the Infinity System Control need not be level to operate properly) and mark wall through two mounting holes.
- Drill two 3/16-in (4.8 mm) mounting holes in wall where marked.
- Secure mounting plastic to wall using two screws and anchors provided.
- Adjust length and routing of each wire to reach each wire entry on the connector backplate. Strip 1/4-in (6.4 mm) of insulation from each wire.
- Match and connect thermostat wires to proper terminals on control backplate. See wiring diagrams in the Wiring Diagrams Section.
- Push any excess wire into the wall. Seal hole in wall to prevent any air leaks. Air leaking from behind the wall can affect measured temperature and humidity, and can affect operation.
- Attach Infinity System Control to the mounting plastic by lining up the plastic guides on the back of the control with the opening on the mounting plastic and push on.
- Perform installation of all other system equipment (i.e. dampers, humidifier, ventilator, UV lights, etc.). See the equipment and device installation instructions for details.
- Turn on power to equipment.

4.6. Humidifier Connections

A 24VAC bypass or fan powered humidifier may be installed.

NOTE: Do NOT use a traditional humidistat to control humidifier operation. If a humidifier is installed, let the Infinity System Control operate humidifier.

4.6.1. Bypass Humidifier

A bypass humidifier should be wired directly to the furnace or fan coil HUM and 24VAC COM terminals. The Infinity System Control will automatically energize the HUM output during a call for humidification.

4.6.2. Fan Powered Humidifiers

Most fan powered humidifiers produce internal 24VAC in order to energize upon a switch or contact closure. For this application, a 24VAC N.O. Isolation Relay (DPST) MUST be used to prevent mixing the internal humidifier power with the indoor equipment transformer. Applying 24VAC isolation relay coil to furnace or fan coil HUM and COM terminals will allow the Infinity System Control to automatically energize the HUM output during a call for humidification. The N.O. relay contacts will be used to energize the humidifier. See Fan Powered Humidifier installation instructions for more details.

5. Commissioning

This section addresses initial power up (or commissioning) of a new Infinity System Control. The control will communicate and identify all components in the Infinity System. The following is a typical example for a communicating variable-speed furnace / fan coil with a 2-stage air-conditioner / heat pump (including HYBRID HEAT® dual fuel system). The process may vary for other types of systems. See the Infinity System HVAC equipment Installation Instructions for more details, as provided.

5.1. Searching for Indoor Unit

The Infinity System Control will light up and display the Carrier logo and then begin the commissioning process by displaying “Searching for indoor unit”.

NOTE: If the Infinity System-compatible indoor equipment (package unit indoor section, gas furnace or fan coil) cannot be found, the control will display “Indoor unit not found”. This **MUST** be corrected before the initial power up sequence can continue, proceeding to the next section, “Searching for outdoor unit.” If it is not corrected, the Infinity System Control will go into its DEMO operating mode. If a control is operating in Demo mode and you wish to install it with equipment, navigate to the Installer menu and perform a re-install to re-learn the equipment.

TIP: Troubleshoot ABCD communication bus problems by removing all but the indoor unit and system control from the ABCD bus circuit. As each bus segment is verified, connect the next component and continue to troubleshoot as required.

5.2. Searching for Outdoor Unit

The Infinity System Control will then proceed to communicate with the outdoor unit by displaying “Searching for outdoor unit”. This includes Infinity small packaged products (SPP) and Infinity System geothermal units.

NOTE: If the outdoor unit cannot be found, the control will display “Outdoor unit not found”.

- Select the appropriate unit installed; then, touch NEXT.

| | | |
|-----------|---|---------------------------|
| AC1Stage | — | 1-stage air conditioner |
| *AC2Stage | — | 2-stage air conditioner |
| *HP1Stage | — | 1-stage heat pump |
| *HP2Stage | — | 2-stage heat pump |
| None | — | No outdoor unit installed |

*. Network Interference Module (NIM) may be required for these selections to be displayed.

NOTE: For some communicating products (SPP and geothermal package units), the selection screen may not be needed and may not appear.

- The installer will first be instructed to select the appropriate size of the outdoor unit; then, touch **SELECT**.

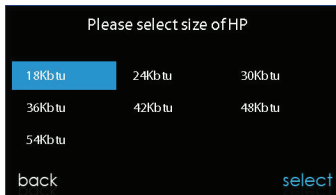
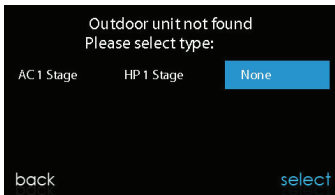

A13118

5.3. Indoor Evaporator Selection

If a furnace is installed with a variable capacity heat pump or an 18VS heat pump or 19VS air conditioner, a screen will appear to select the installed indoor evaporator coil. This selection is used to adequately calculate the refrigerant charge required while in the heat pump charging screens under Refrigerant Charging Greenspeed® Intelligence, 18VSt, 19VSt Systems Section. Select “other” for non-Carrier evaporators.

5.4. Electric Heater Selection

If the indoor equipment is a fan coil, the control will display “Searching for heater” until one is found. If the electric heater is not self-identifying, the select heater screen will appear. Touch the appropriate heater size; then, touch **SELECT**.

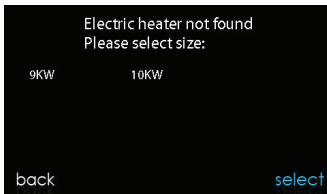
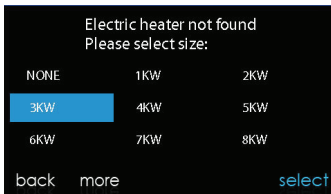

A13119

5.4.1. Hydronic Heat Application

The Infinity System Control supports two types of Hydronic Heat applications:

1. Hot water coil in combination with an FE fan coil and heat pump, or hot water coil as sole heat source with an FE fan coil.
2. Non-zoned FE fan coil combined with radiant hot water heat.

In either application, a Hydronic Heat kit should be installed in place of an electric heater. See FE fan coil Product Data for accessory part number. The system will self-identify that hydronic heat has been installed during electric heater selection. The system will treat the hot water coil as either auxiliary heat in a heat pump application, or the sole heat source. Setup options for Hydronic Heat applications are described in the setup section of this instruction.

NOTE: The daily airflow verification test will take place even when the radiant hydronic heat option is selected.

5.5. Searching for SAM Module (If Applicable)

“Searching for SAM Module” will appear on the screen to determine if a System Access Module, used for home automation only, is connected to the system.

The SYSTXCCSAM01 is not compatible with this control. The compatible modules are SYSTXCCRCT01 and SYSTXCCRWF01. The SAM is used for home automation purposes and is NOT used to connect the system control to the Internet. The Infinity System Control must have at least Version 8 software or newer to be compatible with the SAM.

NOTE: For more information regarding the SAM Module, reference the latest version of the application specification entitled “SAM Remote Access Application Specification, ASCII Protocol Information”, available on HVACpartners.com, or the System Access Module Installation Instructions.



Searching for SAM module

A13117

5.6. Searching for Zones (If Applicable)

“Zoning - Searching” will appear on the screen to determine if any zones are present. The screen will show Zone 1, Zone 2, etc. and indicate all zones having either a Remote Room Sensor, or smart sensors associated with them. If the system contains smart sensors, they must be assigned a zone number before continuing. See the Smart Sensor Installation Instructions on how to assign Smart Sensors to their respective zones. After each zone has been identified, touch **NEXT**.

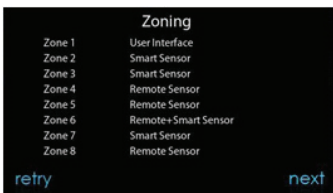
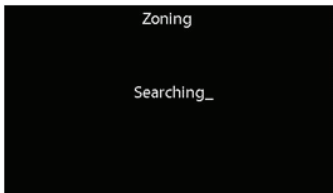

A12185

5.7. Filter Type Selection

The installer will next be prompted to select the air filter type installed with the Infinity System. After the selection is made, touch **NEXT**.

- Air Filter: 1-in. to 4-in. media filter
- EAC: high voltage electronic air cleaner
- Air Purifier: Infinity® Series or Performance™ Series Air Purifier

5.8. Humidifier Installation

Next, the installer will be prompted to select whether a humidifier is installed in the system. Select **YES** or **NO**, then touch **NEXT**.

5.9. Ultraviolet Lights Installation

Next, the installer will be prompted to select whether ultraviolet lights are installed in the system. Select **YES** or **NO**, then touch **NEXT**.

5.10. Equipment Summary

The equipment summary screen will appear after accessories have been selected. This screen will give a summary of all equipment automatically found or manually selected. If an incorrect selection was made, touch **RE-INSTALL** to restart the installation process. See the Infinity System HVAC equipment Installation Instructions for more details, as provided.

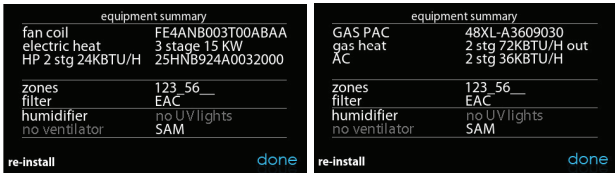

Example: SPP Equipment Summary Screen

A13120

5.11. Airflow Verification Check

The airflow verification check screen will appear next, as the system performs this operation. This process will take about 1-1/2 minutes to complete. When completed, a screen will appear displaying the results of the check.

If the system has an indoor unit equipped with a previous-version CFM-controlled blower system the screen will display the static pressure (in inches of water) across the equipment at the expected highest delivered airflow. If the blower RPM is greater than 1200, a warning will appear, but equipment operation and the TrueSense™ dirty filter detection operation will not be affected. Press **NEXT** when the airflow verification check is complete.

If the system has an indoor unit equipped with an updated-version CFM-controlled blower system (typically found in equipment manufactured after November 2017), the screen will display the static pressure (in inches) across the equipment at a pre-determined target airflow CFM. If the achieved (actual) CFM is unacceptably below the target CFM, a yellow notice will appear to invite the user to see the associated information screen; equipment operation and the TrueSense™ dirty filter detection operation will not be affected. Press **NEXT** when the airflow verification check is complete.

NOTE: The airflow verification check occurs at initial installation, or when **FULL INSTALLATION** or **AIRFLOW VERIFICATION TEST** are selected in the **INSTALLATION & SERVICE** menu.

5.12. Duct Assessment (zoned systems only)

The duct assessment screen will be displayed next for zoned systems. Touch **NEXT** to start Duct Assessment. Duct Assessment will measure the relative size of the ductwork, up to and through the dampers. These measurements are used to control the correct amount of airflow in the zoned system. Status messages will appear on the screen to indicate what the system is doing. The process will take approximately two minutes per zone. The duct assessment will override a call for heat or cool.

A duct assessment will automatically occur each day at a user selectable time. The factory default time is 1:00 p.m. local time but, may be changed by entering the Zoning Setup menu. If there is an active call for heating or cooling, the system will wait until the call is satisfied before it performs the duct assessment. The system will first open all zones and drive the blower to 175 CFM/ton of cooling (or the minimum indoor unit's airflow, whichever is greater). It will then take a static pressure measurement. The system will then close all zones and open one zone at a time, taking a static pressure measurement for each zone.

The system will then close all zones and take a pressure measurement, getting a value for the duct leakage up to and through the dampers. With these static pressure measurements, the system will calculate the relative size of each zone as well as the percent leakage through the dampers at the end of the process, the display will show the relative size of each zone duct.

If the Infinity System Control detects an error (damper not moving or damper wired backwards), it will perform the duct assessment again. If it still detects a damper problem, it will default the measurements into equal sizes, with 10% leakage, and display the zone number for the suspected zone damper.

NOTE: The daily duct assessment will occur even if static pressure monitoring is disabled. This is done to ensure that the system will continue to provide proper airflow for all installed equipment, since duct system changes may occur at any time, such as opened or closed registers.

After the duct assessment is complete, touch **NEXT**.

6. Service Menu

The Service menus contain a set of vital information. This information enables the installer or service person to view a summary of what has been installed, etc. This information is not covered in the Owner's Manual.

To enter service menus, touch menu, then touch and hold the **SERVICE** icon, for at least ten seconds, until the icon turns green. The following screens are available in installation and

service. To return to the previous screen, touch **BACK**. To exit the Service menus, touch **DONE**.

NOTE: See the Owner's Manual for information regarding software upgrades.

NOTE: The user "selection of temperature units" affects the user screens only. The service screens use degree F only. The user "selection of temperature units" is under the display icon on the main menu.

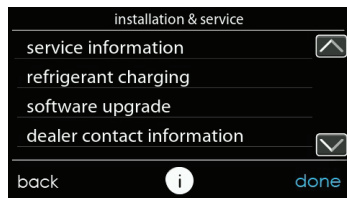
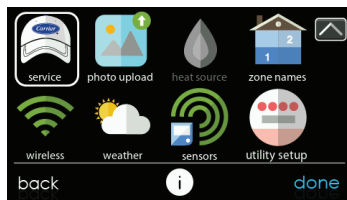

A170181C

6.1. Equipment Summary

Touch **EQUIPMENT SUMMARY** to show indoor unit type and model number, outdoor unit type (and model number if a 2-stage unit), filter type, any accessories that are installed, and the number of zones in the system. To return to the previous screen, touch **BACK**. To exit the Service menus, touch **DONE**.

6.2. Installation

Touch **INSTALLATION** to perform the start-up process in order to learn all equipment in system. Select **FULL INSTALLATION**, then touch **NEXT** to initiate the process.

Touch **Airflow Verification Test** to perform a duct assessment. This can be done if duct modifications have been made since installation of the Infinity System Control. Duct assessment can be performed without performing a full system install.

NOTE: This feature is only available with specific ICP communicating indoor units. See the Ion System Control Product Data for compatible units and more information.

NOTE: For Small Packaged Products (SPP), please use the following instructions for Set-up (Set-Up Section), Checkout (Checkout Section), and Service (Service Information Section):

- For PAC AC Indoor and OAC HP Indoor, follow Fan Coil instructions.
- For Gas PAC Indoor and Gas PHP Indoor, follow Furnace instructions.
- For all PAC Outdoor, follow AC/Heat Pump instructions.

6.3. Set up

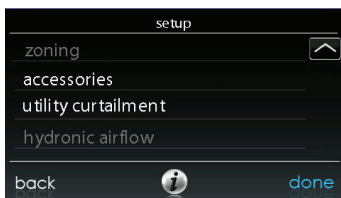
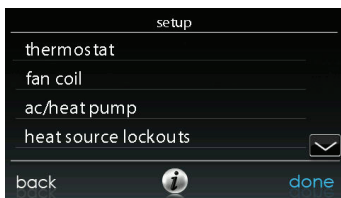

A13130

NOTE: Depending upon the equipment installed, the following options will be displayed. See the Infinity System HVAC equipment Installation Instructions for more details, as provided.

- Indoor:
 - Furnace
 - Fan coil
 - PAC AC Indoor
 - PAC HP Indoor
 - GAS PAC Indoor
 - GAS PHP Indoor
- Outdoor:
 - AC/Heat pump
- Geo HP
- PAC AC outdoor
- PAC HP outdoor
- GAS PAC outdoor
- GAS PHP outdoor

Once the equipment has been selected, the appropriate menus will be displayed.

6.3.1. Thermostat

First touch **SETUP**, then touch **THERMOSTAT** to set up the parameters for the Infinity System Control.

6.3.1.1. Auto Mode Set Up

Once the auto changeover option has been selected, touch **SAVE**.

- **Enable or Disable:** Choose to enable or disable auto changeover mode. Default = Enable
- **Simultaneous Heat/Cool:** Choose to turn simultaneous heat cool demand feature on or off. Default = Off
- If Simultaneous Heat/Cool is turned ON, Auto changeover time is grayed out and shows N/A.
- If Simultaneous Heat/Cool is turned OFF, Auto changeover time: Adjustable from 5 to 120 minutes. Default = 30 minutes

NOTE: AUTO mode is intended to switch between Heating and Cooling modes based on temperature demand. A gradual auto transition is the energy-conscious default that will satisfy the majority of customers. Some customers might have significant and simultaneous heating and cooling demands in different zones. To address this need, a special simultaneous heating and cooling demand auto mode could be enabled by the Installer. The simultaneous heating and cooling demand auto mode will result in higher energy usage but benefit the customer with greater comfort.

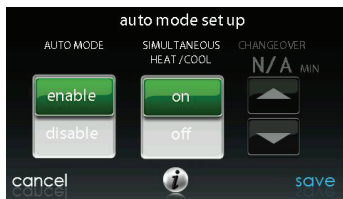

A160183_2

6.3.1.2. Heat/Cool Deadband

The minimum difference enforced between heating and cooling desired temperatures. The deadband does not change when the user changes between Fahrenheit (°F) and Celsius (°C). Ex: A 2° deadband will be 2°F or 2°C and does not change with units, °F and °C. This can allow one setting to “push” the other to maintain this difference. When the correct deadband is set, touch **SAVE**.

- **Deadband:** Adjustable from 0 to 6°. Default = 2°

6.3.1.3. Offsets

This option allows calibration (or deliberate miscalibration) of the temperature and humidity sensors. These offsets are added to the actual temperature/humidity values. See also Zone Offsets Section. When the correct offsets are made, touch **SAVE**. If the system is non-zoned, the indoor temperature offset is found on this screen. If the system is zoned, the indoor temperature offset is found in the Zoning, Offsets screen.

- **Outdoor temperature:** Adjustable from -5 to 5°F (-3 to 3°C). Default = 0°F
- **Indoor temperature:** Adjustable from -5 to 5°F (-3 to 3°C). Default = 0°F
- **Humidity:** Adjustable from -10 – 10%. Default = 0%

NOTE: For single-zone systems, the indoor temperature offset is on this screen. For zoning systems, there is a separate zone indoor temperature offset screen in the zoning menu.

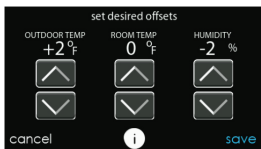

Single-zone Systems

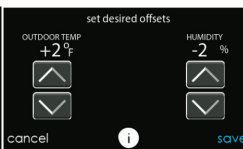

Zoning Systems

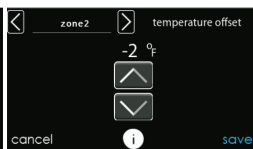

Zoning Systems

A190275

6.3.1.4. Reset Factory Defaults

This option allows the installer to reset certain factory parameters. After the selections are made, touch **SAVE**.

- **Program Schedule:** Reset back to pre-programmed time and temperature.
- **User Settings:** Reset user settings back to pre-programmed values.
- **Install Settings:** Reset installation settings back to pre-programmed values.
- **Last 10 Events:** Reset the last 10 system events under the Service menu.

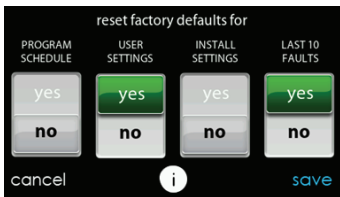

A190397

6.3.1.5. Scheduling On/Off

This option lets the installer allow comfort schedule programming features. After the selection is made, touch **SAVE**.

- **Scheduling:** On or Off. Default = On

6.3.1.6. Smart Recovery On/Off

NOTE: "Smart Recovery" refers to transitions between and among the Home, Sleep and Wake modes. Moving from the Away mode to any other mode is covered by the "Advanced Smart Setback" feature.

Smart Recovery applies to programmable operation only. Smart Recovery causes the system to ramp the system target setpoints to those for the next programmed schedule period to help save energy during period transitions. Smart Recovery will start recovery 90 minutes prior to schedule change in both heating and cooling mode. After the selection is made, touch **SAVE**.

- **Smart Recovery:** On or Off. Default = On

NOTE: The "Temperature Units Display" set-up section has been moved to the Homeowner Screens. See the Owner's Manual for more information.

6.3.2. Fan Coil

First touch **SETUP**, then touch **FAN COIL** to set up the parameters for the fan coil unit.

6.3.2.1. Airflow

This option allows the installer to select the appropriate air flow based on the needs of the installation. The **QUIET** airflow means the minimum cooling airflow that the system can safely run (typically 300 CFM/ton). Use this setting if duct noise is a severe problem. Note that duct sweating in high humidity environments could become an issue at low airflows. The **COMFORT** airflow means airflow is varied depending on humidity and temperature demand settings. This selection enables the full dehumidify and comfort capabilities of the system. The **EFF325** airflow is a fixed airflow used to achieve specified ratings – no dehumidification airflow reduction is performed. This is nominally 325 CFM/ton, but will vary if a 2-stage outdoor unit is used. The **EFF350** airflow is a fixed airflow used to achieve specified ratings – no dehumidification airflow reduction is performed. This is nominally 350 CFM/ton, but will vary if a 2-stage outdoor unit is used. The **MAX** airflow is a fixed 400 CFM/ton. No dehumidification airflow reduction is performed.

NOTE: For Geothermal Heat Pumps, the airflow labels have been changed from EFF325 and EFF350 to EFF1 and EFF2, respectively. Nominal geothermal system airflows for these settings tend to be different than the typical 325 and 350 CFM/ton values.

The dehumidify airflow, when set to **NORMAL**, is allowed to adjust to a minimum to satisfy the dehumidification call. When set to **HIGH**, the minimum airflow during the dehumidify

mode is increased to reduce duct and register sweating. Also the airflow increases minimum airflow during normal cooling operation to help reduce duct sweating.

After the selections are made, touch **SAVE**.

- **Cooling Airflow:** Quiet, Comfort, EFF325 (or EFF1), EFF350 (or EFF2), or Max. Default = Comfort
- **Heating Airflow:** Comfort, EFF325 (or EFF1), EFF350 (or EFF2), or Max. Default = Comfort
- **Dehumidify Airflow:** Normal or High. Default = Normal

6.3.2.2. Altitude

- **Static Pressure selection:** 0 to 10,000 ft. This is used to correct the static pressure readings the system performs.

6.3.2.3. Dehumidification Options

The Dehum Drain Time (Smart Evap™ feature) option turns off the continuous fan at the end of cooling for fifteen minutes in order to drain the indoor coil of water. The fan will only be turned off if a dehumidify demand existed at the start of or during the cooling cycle.

The Electric Reheat option (fan coils, only) enables the electric heat to be used while cool-to-dehumidify is running. This will allow the cool-to-dehumidify function to run longer, greatly improving humidity control in cooling mode. Accumulated electrical energy used while reheating (in kilowatt-hours) is shown on the Fan Coil Run Hours screen and can be reset there. This option is only available with fan coil systems. Self-identifying (staging) heaters provide the best performance for re-heat dehumidification. For reheat applications, 9kW heaters provide the best performance. The reheat algorithm functions along with the overcool algorithm. If the room temperature is low enough that overcooling is not allowed, reheat will not be allowed. Overcooling must happen before the electric heaters are energized.

After the selections are made, touch **SAVE**.

- **Dehum Drain Time:** Adjustable from 5 to 60 minutes or OFF. Default = 15 minutes
- **Electric Reheat:** Yes or No. Default = No

6.3.2.4. Fan Coil G-Terminal Input

This setup option selects desired operation when the **R** to **G** contact is closed on the fan coil control board. Under this function option, **fan** turns on fan to selected fan speed when G terminal is energized. Use the **alert** function to select the contact state for an alert. Select Normally Open or Normally Closed, and then save your selection. **Shutdown** shuts off fan and equipment when initiated. After the selections are made, touch **Save**.

- **Shutdown:**
 - Normally Open
 - Normally Closed

- The shutdown function may not be immediate. Blower off delays, etc., will still be used. The shutdown is not intended for commercial applications. If immediate shutdown is required, provision must be made to remove power to indoor unit.



A13229

6.3.2.5. Fan Coil G-Terminal Alert

Use the **alert** function to select the contact state for an alert. Select **Normally Open** or **Normally Closed**, and then save your selection.



A13230

Shutdown: This setup option selects the change of state required for shutdown. Select **Normally Open** or **Normally Closed**, and then save your selection.

6.3.2.6. Fan Coil G Terminal Alert Label

Once the G Terminal Alert label has been entered, it is shown both on the main screen and in the notification email when the alert becomes active.



A14224

6.3.3. Furnace

First touch **SETUP**, then touch **FURNACE** to set up the parameters for the furnace unit.



A14225A_2

6.3.3.1. Furnace Airflow

Selects the airflow of the furnace when heating. **EFFICIENCY** is the airflow used to meet specified ratings, **COMFORT** is a decreased airflow used to increase the output air temperature and provide increased comfort.

For the Low heat rise option, set to ON if the system contains a bypass humidifier. The ON setting will increase the furnace low heat airflow.

After the selections are made, touch **SAVE**.

- **Furnace Air Flow:** Comfort or Efficiency. Default = Comfort
- **Low Heat Rise:** On or Off. Default = Off

6.3.3.2. AC/HP Airflow

NOTE: For Geothermal Heat Pumps, this option will be shown as 'Geo HP' airflow. This option elects the airflow of the furnace when cooling, heat pump heating, and dehumidification when used with a geothermal heat pump.

The **QUIET** airflow means the minimum cooling airflow that the system can safely run (typically 300 CFM/ton). Use this setting if duct noise is a severe problem.

NOTE: Duct sweating in high humidity environments could become an issue at low airflows.

The **COMFORT** airflow means airflow is varied depending on humidity and temperature demand settings. This selection enables the full dehumidify and comfort capabilities of the system. The **EFF325** (or EFF1) airflow is a fixed airflow used to achieve specified ratings – no dehumidification airflow reduction is performed. This is nominally 325 CFM/ton, but will vary if a 2-stage outdoor unit is used. The **EFF350** (or EFF2) airflow is a fixed airflow used to achieve specified ratings – no dehumidification airflow reduction is performed. This is nominally 350 CFM/ton, but will vary if a 2-stage outdoor unit is used. The **MAX** airflow is a fixed 400 CFM/ton. No dehumidification airflow reduction is performed.

NOTE: For Geothermal Heat Pumps, the airflow labels have been changed from EFF325 and EFF350 to EFF1 and EFF2, respectively. Nominal geothermal system airflows for these settings tend to be different than the typical 325 and 350 CFM/ton values.

The dehumidify airflow, when set to **NORMAL**, the airflow is allowed to adjust to a minimum to satisfy the dehumidification call. When set to **HIGH**, the minimum airflow during the dehumidify mode is increased to reduce duct and register sweating. Also the airflow increases minimum airflow during normal cooling operation to help reduce duct sweating.

After the selections are made, touch **SAVE**.

- **Cool:** Quiet, Comfort, EFF325 (or EFF1), EFF350 (or EFF2), or Max. Default = Comfort
- **HP Heat:** Comfort, EFF325 (or EFF1), EFF350 (or EFF2), or Max. Default = Comfort
- **Dehumidify:** Normal or High. Default = Normal

6.3.3.3. Furnace Staging

This option controls the staging of the furnace and selects the minimum amount of time low stage must operate before high stage is activated. **SYSTEM** setting will allow the Infinity Zone Control to determine furnace staging. **LOW** will only run the low stage of furnace heat. **LOW-MED** will run the low and medium stages (2 stages of heat). **MED** will only run the medium stage of heat. **MED-HIGH** will run the medium and high stages (2 stages of heat). **HIGH** will only run the high stage of furnace heat.

NOTE: Two-stage furnace has **LOW** and **HIGH** selections only.

- **Stages:** System, Low, Low-Med, Med, Med-High, or High. Default = System

6.3.3.4. Furnace Airflow Limits (modulating furnace only)

The following settings allow the installer to restrict the furnace within certain minimum and maximum airflows. These airflows are converted to capacities. The Min and Max limits are determined by the equipment size. These settings are not the same as the zoning airflow limits.

- **Min. modulating limits:** Minimum CFM to run a modulating furnace. This will increase the minimum operating capacity of the furnace. Default value is the furnace air flow for the lowest heat capacity.
- **Max. modulating limits:** Maximum CFM to run a modulating furnace. This will increase the maximum operating capacity of the furnace. Default value is the furnace air flow for the highest heat capacity

6.3.3.5. Furnace Off Delay

This option denotes the amount of time the blower will continue to run after heating has shut off. After the selection is made, touch **SAVE**.

- **Furnace Off Delay:** 90, 120, 150 or 180 seconds. Default = 120 seconds

6.3.3.6. Altitude

For gas de-rating, this setting will adjust the furnace's airflow to compensate for altitude. Altitude adjustment is not available with older furnaces. Please see furnace instructions for further details. After the selection is made, touch **SAVE**.

- **Altitude:** 0000 – 2000, US 2001 – 3000, CN 2100 – 4500, US 3001 – 4000, US 4001 – 5000, US 5001 6000, US 6001 – 7000, US 7001 – 8000, US 8001 – 9000, and US > 9000. Default = US 2001-3000
- **Static Pressure selection:** 0 to 10,000 ft. This value is used to correct the static pressure readings the system performs.

6.3.3.7. Furnace Dehumidifier Drain

This option selects the time the continuous fan turns off at the end of cooling in order to drain the indoor coil of water (Smart Evapt feature). The fan will only be turned off if a dehumidify demand existed at the start of or during the cooling cycle.

- **Dehumidify Drain Time:** Adjustable from 5 to 60 minutes. Default = 15 minutes

6.3.3.8. Furnace G Terminal

This setup option selects desired operation when the R-G circuit changes state on the furnace control board depending on setup.

Under the function option, **FAN** turns on fan to selected fan speed when G terminal is energized. **SHUTDOWN** shuts off fan and equipment when initiated.

After the selections are made, touch **SAVE**.

- **Function:** Disabled, Fan or Shutdown. Default = Disabled
- **Fan Speed:** Low, Med, or High. Default = Low
- **Shutdown:**
 - Normally Open
 - Normally Closed
 - The shutdown function may not be immediate. Blower off delays, etc., will still be used. The shutdown is not intended for commercial applications. If immediate shutdown is required, provision must be made to remove power to indoor unit.

6.3.3.9. Furnace G-Terminal Alert

Use the **alert** function to select the contact state for an alert. Select **Normally Open** or **Normally Closed**, and then save your selection.



Shutdown: This setup option selects the change of state required for shutdown. Select **Normally Open** or **Normally Closed**, and then save your selection.

6.3.3.10. Furnace G Terminal Alert Label

Once the G Terminal Alert label has been entered, it is shown both on the main screen and in the notification email when the alert becomes active.

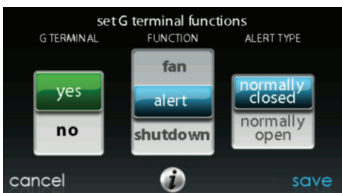

A1470248

6.3.4. AC/Heat Pump

First touch **SETUP**, then touch **AC/HEAT PUMP** to set up the parameters for the AC/Heat Pump unit.



A14227A_2

6.3.4.1. Latching

High Cool Latch

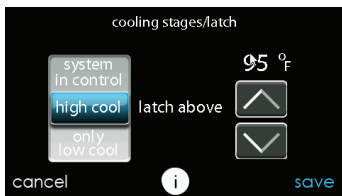

A13227A

- **System in Control:** The system will decide which stage should be running to satisfy the cooling demand.

- High Cool: Temperature above which only the high stage of cooling will be energized.
- Only Low Cool: The system will only run in low stage cooling.

High Heat Latch

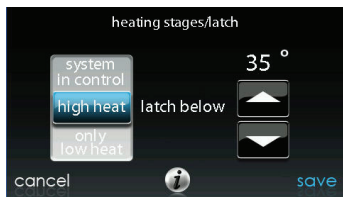

- System in Control: The system will decide which stage should be running to satisfy the heating demand.
- High Heat: Temperature below which only the high stage of heating will be energized.
- Only Low Heat: The system will only run in low stage heating.

6.3.4.2. Cooling Lockout

Outside temperature below which cooling will not be provided. After the selection is made, touch SAVE.

- **Cooling Lockout Temp:** None, 45, 50 or 55 (°F). Default = None

NOTE: When simultaneous heating and cooling demand feature is on, the cooling lockout shall be ignored.

6.3.4.3. Defrost Interval

Time interval at which defrost cycles can occur on a heat pump. **AUTO** means the defrost interval is optimized by the outdoor control. After the selection is made, touch **SAVE**.

- **Set Defrost Interval:** 30, 60, 90, 120 minutes or **AUTO**. Default = **AUTO**

NOTE: See Heat Pump Installation Instructions for Defrost Timing Interval when using **AUTO** Defrost.

6.3.4.4. Low Ambient Cooling

Selecting **YES** will enable the low ambient cooling operation in the outdoor unit. This setting is only available with compatible communicating outdoor units and with Cooling Lockout set to **NONE**. Low ambient kits are not needed with many communicating outdoor units. Refer to the outdoor unit Product Data or Installation Instructions for more information. After the selection is made, touch **SAVE**.

- **Low Ambient Cooling:** Yes or No. Default = No

6.3.4.5. Quiet Shift

This option turns on Quiet Shift function in 1-stage or 2-stage communicating heat pumps. After the selection is made, touch **SAVE**.

NOTE: This option is not available with variable speed heat pumps nor geothermal units.

- **Quiet Shift:** On or Off. Default = Off

6.3.4.6. AC/Heat Pump RPM Max

Used with variable capacity heat pumps, this option clamps the operating speed of the heat pump to this maximum. Used to reduce operating noise while in high heating capacity. Reducing this value will reduce the heating capacity of the heat pump. After the selection is made, touch **SAVE**.

- **AC Heat Pump Max RPM:** Adjustable from 4500 – 7000. Default = 7000 RPM

6.3.4.7. Defrost Fan Delay

Turns on the outdoor unit fan at the end of a defrost cycle for approximately 12 seconds. This helps to reduce any nuisance refrigerant noise caused by the switching reversing valve. This setup is only available on communicating heat pumps. After the selection is made, touch **SAVE**.

- **Defrost Fan Delay:** Yes or No. Default = No

6.3.4.8. Brownout Disable

This option turns off the high voltage brownout detection function in the outdoor unit control. After the selection is made, touch **SAVE**.

- **Brownout Disable:** On or Off. Default = Off

6.3.4.9. Low Air Multiplier

Adjusts the airflow speed on non-communicating two-stage units. Choose 0.65 for units with a Bristol compressor, choose 0.80 (default) for units with a Copeland scroll compressor.

6.3.4.10. Energy Efficiency

This option is used to input the published ratings of the installed air conditioner or heat pump as part of the energy tracking calculation. After the ratings are entered, touch **SAVE**.

6.3.5. Heat Source Lockout

First touch **SETUP**, then touch **HEAT SOURCE LOCKOUTS** to set up the parameters for the AC/Heat Pump unit.

For hydronic heat applications, this option allows the installer to set the lockout temperatures below which only the hydronic coil will operate, and the lockout temperature above which the hydronic coil will not operate. After the selections are made, touch **SAVE**.

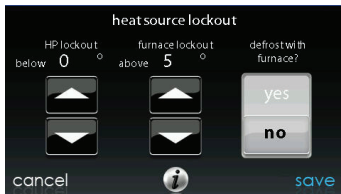

A12149

- **HP Lockout:** Adjustable from -20 to 55°F (-28 to 13°C) or None. Default = None
- **Furnace, Electric Heat or Hydronic Lockout:** Adjustable from 15 to 55°F (-9 to 13°C) or None. Default = None
- **Defrost with Furnace, Electric Heat or Hydronic:** Yes or No. Default = Yes
 - For Geothermal units, lockout for auxiliary heat (furnace or electric resistance) is not enabled.

NOTE: When simultaneous heating and cooling demand feature is ON, the system will try to respect the settings for heat source but may override the settings if the preferred heat source is unable to deliver heat.

6.3.6. Stages / Latch for 18VS

For 18VS heat pumps, the cooling and heating stage/latch can be changed. Select cooling or heating next to stages/latch. The maximum stage and the minimum stage can be selected. The minimum selected stage can be locked-in or set based upon the outside temperature.

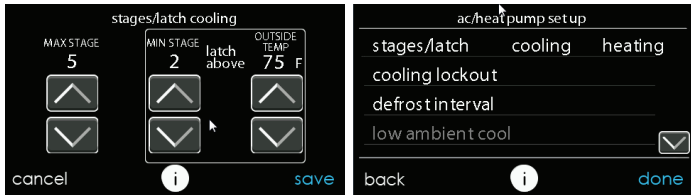

A14228A

6.3.7. Geothermal HP (when available)

First touch **SETUP**, then touch **Geo HP** to set up the parameters for the Geo HP unit.

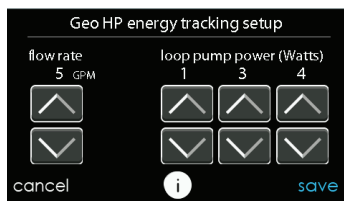
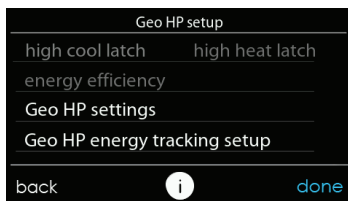
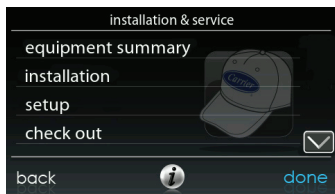

A160188C

6.3.7.1. Freeze Limits

This setting controls the temperature level to which the loop liquid can drop before the Geo HP unit will stop operating. See the Geo HP Installation Instructions for more details. Typically, 26°F is chosen for open-loop systems using untreated water; and 15°F is chosen for closed-loop systems using glycol or other anti-freeze solutions. After the selection is made, touch **SAVE**.

- **Freeze Limits:** 26°F or 15°F. Default = 26°F

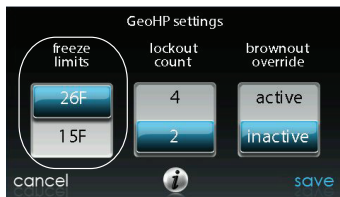

A150179

6.3.7.2. Lockout Count

This setting controls the number of times within an hour that the HPS or LPS trips before the Geo HP compressor will lockout for four hours. After the selection is made, touch **SAVE**.

- **Lockout Count:** 4 or 2
- Default = 2

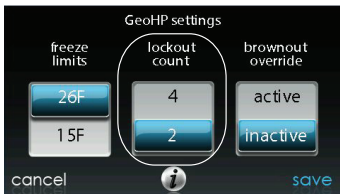

A150180

6.3.7.3. Brownout Override

This option controls the low voltage brownout override function in the Geo HP unit. After the selection is made, touch **SAVE**.

- **Brownout Override:** Active or Inactive. Default = Inactive

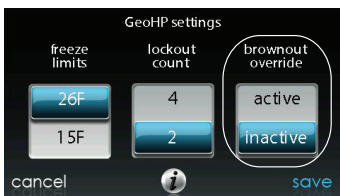

A150181

6.3.7.4. Geothermal HP Energy Tracking

Energy tracking for geothermal heat pumps requires the installation of an Entering Water Temperature (EWT) sensor. See the geothermal heat pump literature for information on installing this sensor.

If the EWT sensor is installed, the installer will be able to enter the Loop Flow Rate and the Loop Pump power. See the figure in the Geothermal HP Section. These inputs will help the Energy Tracking algorithm properly calculate geothermal heat pump usage. See the geothermal heat pump literature for details.

If the EWT error message is shown, as illustrated in the Geothermal HP Section, that means that the EWT sensor was installed and had valid readings at one time, but is now malfunctioning. See the geothermal heat pump literature for details.

6.3.8. Zoning (If Applicable)

First touch **SETUP**, then touch **ZONING** to set up the parameters for the zoning system (if applicable).

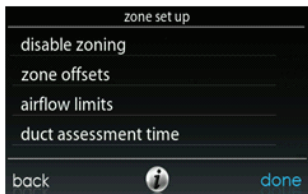

A12191

6.3.8.1. Disable Zoning

This option allows the installer to enable or disable zoning. After the selection is made, touch **SAVE**.

- **Disable Zoning:** Yes or No. Default = No

6.3.8.2. Zone Offsets

This option allows actual temperature offset for each zone, allowing calibration (or deliberate miscalibration) of each sensor. Use the Left (<) or Right (>) buttons to change the zone. After the selection is made, touch **SAVE**.

- **Temperature Offset:** Adjustable between -5 to 5°F (-3 to 3°C). Default = 0°F

6.3.8.3. Airflow Limits

Since a bypass damper is prohibited in this system, this setting is used to select the maximum allowable noise/airflow relationship into each zone based on air noise and comfort requirements. **LOW** means 100% of maximum assessed airflow; **MED-LOW** means 138% of maximum assessed airflow; **MEDIUM** means 176% of maximum assessed airflow; **MED-HIGH** means 214% of maximum assessed airflow; **HIGH** means 250% of maximum assessed airflow; and **NO LIMIT** means the equipment does not stage down due to airflow, but the system may stage down due to high static pressure.

CFM associated for each limit is shown on the screen. Compare this value with the equipment's low stage CFM value to ensure that equipment will run for each zone. Assessed airflow is determined as described in **DUCT ASSESSMENT**.

After the selections are made, touch **SAVE**.

- Touch the zone name that you wish to change
- **Select the zone to adjust airflow:** Low, Med-Low, Medium, Med-High, High, or No Limit. Default = High

6.3.8.4. Duct Assessment Time

NOTE: The daily duct assessment will occur even if static pressure monitoring is disabled. This is done to ensure that the system will continue to provide proper airflow for all installed

equipment, since duct system changes may occur at any time, such as opened or closed registers.

This option allows the installer to select the time in which the duct assessment will be performed. After the selection is made, touch **SAVE**.

- **Duct Assessment Time:** Selectable between 12 AM and 11PM. Default = 1 PM

6.3.9. Accessories

First touch **SETUP**, then touch **ACCESSORIES** to set up the parameters for the accessories installed with the system.

6.3.9.1. Filter

NOTE: The daily duct assessment will occur even if static pressure monitoring is disabled. This is done to ensure that the system will continue to provide proper airflow for all installed equipment, since duct system changes may occur at any time, such as opened or closed registers.

With this option, the installer has the option of selecting pressure monitoring, the type of filter installed, and the time interval for cleaning. After the selections are made, touch **SAVE**.

- **Pressure Monitoring** (not available or effective with air cleaners that do not use filter media, such as Electric Air Cleaners): Enable or Disable. Default = Enable
- **Clean Interval:** Selectable from 1 to 18 months. Default = 3 months
- **Filter Type:** Air Filter, Electric Air Cleaner or Air Purifier. Filter type is selected during installation; otherwise default = air filter

6.3.9.2. Humidifier

With this option, the installer has the option of selecting whether a humidifier is installed, to humidify with the fan in low speed, and the time interval for changing the humidifier pad. After the selections are made, touch **SAVE**.

- **Humidifier Installed:** Yes or No. Humidifier selection made during installation; otherwise default = No
- **Change Pad:** Selectable from 1 to 24 months. Default = 12 months
- **Humidify with Fan:** Yes or No. Default = No

6.3.9.3. Ultraviolet Lights

With this option, the installer has the option of selecting whether ultraviolet lights are installed, and the time interval for changing the ultraviolet lights. After the selections are made, touch **SAVE**.

- **UV Lights Installed:** Yes or No. UV Lights selection made during installation; otherwise default = No
- **Change Interval:** Selectable from 1 to 48 months. Default = 12 months

6.3.9.4. Ventilator

When a ventilator is installed, the installer has the option of selecting the time interval for cleaning the ventilator. After the selections are made, touch SAVE.

- Clean Interval: Selectable from 60, 90, 120, 150 or 180 days. Default = 90 days

NOTE: This option may NOT be available with the ERVXXNVA ventilator due to its simplified control design.

6.3.10. Utility Curtailment

NOTE: Utility Curtailment and Utility Saver functions are different than the Utility Demand Response function described in the Owner's Manual. Utility Curtailment/Utility Saver uses the UTIL and Y2 (or equivalent) terminals on the Infinity System compressor section control board to receive a dry contact relay signal from the Utility, typically from the electric meter assembly, to signal a curtailment period. This section describes the actions taken in response to that signal. See the equipment installation instructions for more information on wiring the compressor section control board to the Utility connections.

Utility Saver is used to force the equipment to a lower stage (low or off) when activated by the utility company, typically during peak load times. This setup is available only if the equipment has a utility saver input (refer to outdoor equipment installation instructions). This setup controls the response of the equipment when the utility saver input is active. **DISABLED** means that the curtailment function is not active. **TURN OFF** means the outdoor unit is to be turned off when the curtailment function is active. **LOW STAGE** means the outdoor unit will run in low stage when the curtailment function is active. After the selections are made, touch **SAVE**.



- **Cooling:** Disabled, Low Stage or Turn off. Default = Disabled
- **Heat Pump:** Disabled, Low Stage or Turn off. Default = Disabled

A12193

6.3.11. Hydronic Airflow

NOTE: The daily duct assessment will occur even if Hydronic Airflow is set to Off. This is done to ensure that the system will continue to provide proper airflow for all installed

equipment, since duct system changes may occur at any time, such as opened or closed registers.

This option allows the installer to select the airflow for the fan coil when paired with a hydronic coil. After the selections are made, touch **SAVE**.

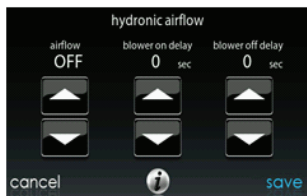

- **Airflow:** Selectable between Off to Max in 50 CFM increments. Default = Off, 500 CFM, Max = (odu_size in KBTU * 400/12) A12194

NOTE: Selected airflow used during hydronic heating is a fixed value, it does not vary.

- **Blower On Delay:** Selectable from 0 to 240 seconds. Default = 30 seconds
- **Blower Off Delay:** Selectable from 0 to 240 seconds. Default = 0 seconds

6.4. Check out



WARNING

PROPERTY DAMAGE AND/OR PERSONAL INJURY HAZARD

Failure to follow this warning could result in property damage, personal injury or death. Before running Check Out mode, make sure that all HVAC equipment is properly installed. See the equipment installation instructions for details and additional safety information.

Touch **CHECKOUT** to view the equipment installed in the system. Perform checkout test to make sure each piece of equipment is operating properly.

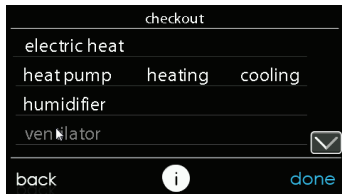

A13122A

6.4.1. Electric Heat

If you have a fan coil with electric heaters, this menu item will allow the heaters to be exercised. With self-identifying electric heaters, three stages of electric heat are available to be exercised in any combination. Non-identifying heaters will only provide one stage of heat; or perhaps may have fixed-timed staging. See the instructions provided with the electric heat accessory. After the selections are made, touch **START**.

- **Low Heat:** Selectable from 0 to 120 minutes. Default = 5 minutes
- **Medium Heat:** Selectable from 0 to 120 minutes. Default = 5 minutes
- **High Heat:** Selectable from 0 to 120 minutes. Default = 5 minutes

6.4.2. Furnace

Make sure the furnace is properly installed.

This option allows the furnace to be exercised. First, a low heat run time and high heat run time are selected. The furnace will execute its ignition start-up sequence. This sequence will be displayed on the screen. After the gas valve and blower motor turn on, the screen will show the current operating status of the furnace. After the selections are made, touch **START**.

- **Low Heat:** Selectable from 0 to 120 minutes. Default = 5 minutes
- **High Heat:** Selectable from 0 to 120 minutes. Default = 5 minutes

6.4.3. Hydronic

This option allows the hydronic heat relay to be exercised. First, it will energize the relay and turns on the blower. This sequence will be displayed on the screen. After the selections are made, touch **START**.

- **Hydronic heater check:** Selectable from 0 to 120 minutes. Default = 5 minutes

6.4.4. Air Conditioning

This option allows the air conditioner to be exercised. With a 2-stage AC unit, a low cool and a high cool run time are independently selectable to exercise. The display will change to show the AC operating status. After the selections are made, touch **START**.

For 18VS heat pumps, you can select the stage at which the heat pump will exercise. During the checkout, the stage and time can be changed by pressing the Change button on the checkout status screen.

NOTE: Airflows during Checkout modes are fixed to the **EFFICIENCY** setting and are independent of other airflow settings. To view airflows for normal air conditioning cooling mode, exit the **CHECKOUT** screen and apply a heating demand to the system.

- **Low Cool Run Time:** Selectable from 0 to 120 minutes. Default = 5 minutes
- **High Cool Run Time:** Selectable from 0 to 120 minutes. Default = 5 minutes

6.4.5. Heat Pump Heating

The heat pump heating mode can be exercised with this menu option. With a 2-stage heat pump, a Low Heat and a High Heat Run Time are independently selectable to exercise.

For variable speed heat pumps, you can select the speed at which the heat pump will exercise.

For VS heat pumps, you can select the stage at which the heat pump will exercise. During the checkout, the stage and time can be changed by pressing the Change button on the checkout status screen.

After the selections are made, touch **START**.

NOTE: Airflows during Checkout modes are fixed to the **EFFICIENCY** setting and are independent of other airflow settings. To view airflows for normal air conditioning cooling mode, exit the **CHECKOUT** screen and apply a heating demand to the system.

- **Low Heat Run Time:** Selectable from 0 to 120 minutes. Default = 5 minutes
- **High Heat Run Time:** Selectable from 0 to 120 minutes. Default = 5 minutes
- **Speed (variable speed heat pump only):** Selectable from lowest available to 100%. Default = lowest available as specified by variable speed heat pump
- **Defrost:** Yes or No. Default = No (For Geothermal Heat Pumps, this option is not available.)

6.4.6. Heat Pump Cooling

The heat pump cooling mode can be exercised with this menu option. With a 2-stage heat pump, a Low Cool Run Time and a High Cool Run Time are independently selectable to exercise.

For variable speed heat pumps, you can select the speed at which the heat pump will exercise.

For 18VS heat pumps, you can select the stage at which the heat pump will exercise. During the checkout, the stage and time can be changed by pressing the Change button on the checkout status screen.

After the selections are made, touch **START**.

NOTE: Airflows during Checkout modes are fixed to the **EFFICIENCY** setting and are independent of other airflow settings. To view airflows for normal air conditioning cooling mode, exit the **CHECKOUT** screen and apply a heating demand to the system.

- **Low Cool Run Time:** Selectable from 0 to 120 minutes. Default = 5 minutes
- **High Cool Run Time:** Selectable from 0 to 120 minutes. Default = 5 minutes
- **Speed (variable speed heat pump only):** Selectable from lowest available to 100%. Default = lowest available as specified by variable speed heat pump

6.4.7. Humidifier

The humidifier can be exercised On and Off with this menu option. To end the humidifier checkout, touch **STOP**.

- **Humidifier Check:** On or Off

6.4.8. Ventilator

The ventilator can be exercised through all of its operating speeds with this menu option. To end the ventilator checkout, touch **STOP**.

- **Humidifier Check:** High, Low or Off

NOTE: This option may NOT be available with the ERVXXNVA ventilator due to its simplified control design.

6.4.9. Zoning (If Applicable)

6.4.9.1. Airflow Limits

Because there is no bypass damper, the zone airflow limit check will allow the installer to assess the airflow noise generated by the system providing the maximum amount of airflow to each zone. Touch **AIRFLOW LIMITS**: When **START** is touched, the selected zone's damper will fully open, all others will close, and the indoor unit will provide the maximum airflow for that zone (as selected in **SETUP — ZONING, Airflow Limits**). If the airflow noise is objectionable, the installer can select a lower airflow noise limit. If the noise is not objectionable, the installer should leave **HIGH** selected, or even **NO LIMIT**.

NOTE: Selecting a lower airflow noise limit may decrease the homeowner's comfort in that zone.

Touch the Left (<) or Right (>) buttons to change the desired zones. Once the proper airflow limits are set, touch **SAVE**, to see **ZONING CHECKOUT** menu.

6.4.9.2. Damper/Sensor Check

The Sensor/Damper Check allows the installer to check each zone damper for operation, as well as insure the zone sensor corresponds to that particular zone. When first initiated, the Zone 1 damper will fully open, and all other zones will close. Using the Left (<) or Right (>) buttons, the installer can select each zone and verify the damper is fully open while all other dampers remain closed.

After proper damper operation has been verified, the installer can now check and verify that each Remote Room Sensor corresponds to the proper zone damper in the same zone. For systems with remote room sensor, temporarily disconnect any other zone Remote Room Sensor (at sensor location). That zone damper will now open, while the Zone 1 damper will close.

For systems using Smart Sensors, the installer may press and hold the Hold and Mode buttons simultaneously for 3 seconds to change the zone under test. This should be done with each zone to verify that the zone sensor corresponds to that particular zone.

Once each zone has been checked, touch **DONE** to return to the **ZONING CHECKOUT** menu.

6.4.9.3. Zone Duct Assessment

This screen shows the results from the previous duct assessment. The duct assessment is performed at initial start-up and at 1 P.M. or the installer selected time each day. If another duct assessment is desired, the service technician should perform a re-install of the system.

NOTE: A Duct Assessment will automatically occur every 24 hours at selected time to check system static and calibrate dampers.

Once the duct assessment is complete, touch **DONE** to return to the **ZONING CHECKOUT** menu.

6.4.9.4. Sensor Type

This option shows a list of all zones with corresponding sensor types.

6.5. Service Information

The Service Info menu will only show the equipment installed in the system. To enter this menu of options, touch **SERVICE INFORMATION**.



A13123A

6.5.1. Advanced Diagnostics

When viewing the Service Information screen, there is a button labeled View Diagnostics, which provides the top 3 most likely root causes for the most recent fault.

NOTE: This feature is only available with compatible models. See the Infinity equipment product data or installation instructions for more information.

6.5.2. Fan Coil Status

The fan coil status screen displays relevant information about the fan coil operation. To return to the previous screen, touch **BACK**. To exit the Service menus, touch **DONE**.

| fan coil status | |
|-------------------------|---------|
| electric heat stage | 1 |
| airflow CFM | 555 |
| blower RPM | 1200 |
| static pressure | 0.66 in |
| leaving air temperature | 65 |
| indoor coil temperature | 45 |

back  done

A12197

6.5.3. Furnace Status

The furnace status screen displays relevant information about the furnace operation. To return to the previous screen, touch **BACK**. To exit the Service menus, touch **DONE**.

| furnace status | |
|-------------------------|-------|
| furnace heat stage | MED |
| airflow CFM | 555 |
| blower RPM | 1200 |
| static pressure | 66 in |
| inducer RPM | 123 |
| leaving air temperature | 65 |
| lockout time left | 180 |

back  done

A12198

6.5.4. AC Status

The AC status screen displays relevant information about the AC operation. To return to the previous screen, touch **BACK**. To exit the Service menus, touch **DONE**.

NOTE: Screen data will vary based on unit installed.

| air conditioner status | |
|--------------------------|---------|
| air conditioner | stage 1 |
| indoor airflow CFM | 555 |
| leaving air temperature | 65 |
| outdoor coil temperature | 23 |
| blower RPM | 1200 |
| line voltage | 119 |
| lockout timer | 45 |

back  done

A12199

6.5.5. Heat Pump Status

The heat pump status screen displays relevant information about the heat pump operation. To return to the previous screen, touch **BACK**. To exit the Service menus, touch **DONE**.

NOTE: Screen data will vary based on unit installed.

| heat pump status | |
|-------------------------|------|
| cool stage | off |
| indoor airflow CFM | 1000 |
| leaving air temperature | 99 |
| indoor coil temperature | 99 |
| line voltage | 120 |
| lockout timer | 99 |

back  done

A12200

6.5.6. Geothermal HP Status

The Geo HP status screen displays relevant information about the Geo HP operation. To return to the previous screen, touch **BACK**. To exit the Service menu, touch **DONE**.

NOTE: Screen data will vary based on unit installed.

| Geo HP status | |
|-------------------------|------------|
| heat pump cooling | dehumidify |
| indoor airflow CFM | 555 |
| leaving air temperature | 65 |
| entering water temp. | 50 |
| blower RPM | 1200 |
| coax freeze sensor | 30 |
| line voltage | 119 |
| lockout timer | 45 |

back  done

A160192

6.5.7. Zoning Status

The zoning status screen displays relevant information about the zoning operation. To return to the previous screen, touch **BACK**. To exit the Service menus, touch **DONE**.

6.5.8. Last 10 System Events

This screen will show the last 10 events that occurred throughout the system. Each entry has the time and date incident recorded. These events are stored in the memory of the control and are resettable in the **THERMOSTAT SETUP** screen under the **RESET FACTORY DEFAULT** selection. Each entry shows the equipment that generated the event. To return to the previous screen, touch **BACK**. To exit the Service menus, touch **DONE**.

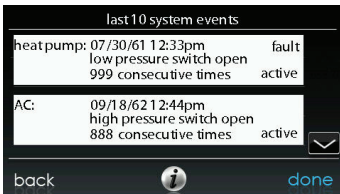

A12151

6.5.9. Run/Fault History

This information is stored in the equipment circuit boards (if communicating) and displayed on the control. The indoor unit and outdoor unit (if communicating) have the following histories. To return to the previous screen, touch **BACK**. To exit the Service menus, touch **DONE**.

- **Resettable Faults:** Fault counters for each piece of equipment that can be reset.
- **Cycle Counters:** Number of heat/cool/power cycles the unit has performed.
- **Run Times:** Lifetime hours of operation in heating, cooling, and how long the unit has been powered.

6.5.10. Model/Serial Numbers

This menu item allows the installer to view the model number, serial number (if available), and control software version (if available) of all communicating pieces of equipment in the system, including the wall control. This information resides in the original equipment circuit board(s) from the factory. If an equipment circuit board has been replaced, the model and serial number will no longer be displayed. To return to the previous screen, touch **BACK**. To exit the Service menus, touch **DONE**.



A14230

6.5.11. Service Phone Number

This menu item allows the installer to view the name and phone number that the homeowner can call for future service of the system. This name and phone number will appear to the homeowner whenever a service reminder pop-up message is displayed (i.e. Change Filter, etc.).

The contact number can be changed under the dealer system menu. To return to the previous screen, touch **BACK**. To exit, touch **DONE**.

6.5.12. Energy Tracking

NOTE: Energy Tracking is only available for applicable equipment. See The Product Data for the equipment in question to see if Energy Tracking is available for that device. Both indoor and outdoor units must have energy tracking capability for this feature to function fully.

This menu item allows the installer to view the energy usage of each piece of equipment connected to the system. To return to the previous screen, touch **BACK**. To exit the Service menus, touch **DONE**.

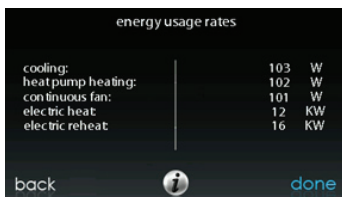

| energy usage rates | | |
|--------------------|--|-------|
| cooling: | | 103 W |
| heat pump heating: | | 102 W |
| continuous fan: | | 101 W |
| electric heat | | 12 KW |
| electric reheat | | 16 KW |

back  done

6.6. Refrigerant Charging: Greenspeed® Intelligence, 18VS™, 19VS™ Systems

A14231

For variable capacity and multi-stage heat pumps and AC units, a refrigerant charging menu is available to aid in the proper charging of the system. Enter the menu from the service screens by touching **REFRIGERANT CHARGING**.

The option for **HTG CHECK CHARGE** is only available for heat pump units, and not available in AC units.

NOTE: See the outdoor equipment Installation Instructions for information on what conditions **CHARGING COOLING** and **HTG CHECK CHARGE** are available.

6.6.1. Charging

Within the **CHARGING COOLING** or **HTG CHECK** screens, the installer will have the ability to enter the **LINESET** length and the **VAPOR LINE** diameter. After the selections are made, touch **NEXT**.

- **Lineset:** Selectable from 5 to 200 feet

NOTE: For 18/19 VS product, 100 feet is the maximum allowed refrigerant line length.

- **Vapor line:** Selectable with various diameters by using the up and down buttons

Next, the installer will enter the **WEIGH IN** screen to verify the current total charge is accurate. Once the installer has confirmed, touch **DONE**.

Next, the installer will enter the **SERVICE VALVE SUBCOOL** screen. This screen will show the current liquid line subcool target (in °F). To begin the charging, touch **START**. If the outdoor temperatures are not in the required range, Service Valve Subcool may not be available. For **HTG CHECK CHARGE**, the option Service Valve Subcool is unavailable.

Next, the installer will enter the **SERVICE VALVE INFORMATION** screen. The current liquid line subcool target, stabilization time, mode and speed in rpm, EXV position in percent, indoor airflow in CFM, outdoor coil temperature in °F, indoor temperature in °F, outdoor temperature in °F, compressor discharge pressure in psig, and accumulator suction pressure in psig are displayed on this screen. Once the stabilization time has expired, touch **DONE**.

NOTE: Screen data will vary based on unit installed.

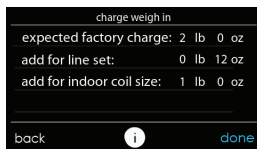
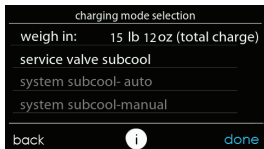
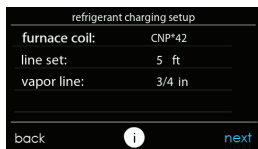

A14286A_2



A14664a

6.6.2. Pump Down

Because this system has an inverter controlled compressor, suction pressure transducer and EXV, conventional procedure cannot be used to “pump down” and isolate the refrigerant into the outdoor unit. The control has provisions to assist in performing this function.

- Select mode to pump down in (**COOL** or **HEAT**). **COOL** mode allows refrigerant to be isolated in outdoor unit. **HEAT** mode allows the refrigerant to be isolated in indoor coil and lineset. Set desired time period. Default time period for procedure is 120 minutes.
- Touch **START** to begin the pump down process. Unit will begin running in selected mode after a brief delay.

6.6.3. Evacuation

Because this system has an EXV for the heating expansion device, additional steps must be taken to open the EXV if the heat pump unit must be evacuated for service reasons. If the EXV is not open when pulling a vacuum or recovering refrigerant from the heat pump unit, extended evacuation time may be required and/or inadequate vacuum obtained. The control has provisions to open the EXV for refrigerant recovery and/or evacuation.

- Set desired time period. Default time period for procedure is 120 minutes.
- Touch **START** on Infinity System Control or service tool to open the valve.
- Begin evacuation or refrigerant recovery as required for the procedure after control indicates the EXV is open. Power may be removed from heat pump after the control indicates “**READY TO EVACUATE.**”

6.6.4. EXV Position

This screen allows the installer to set the EXV position and monitor the suction pressure.

NOTE: Screen data will vary based on unit installed.



A14233

6.7. Dealer Logo

NOTE: More detailed information can be found on HVACPartners.com under: Products and Dashboards > Product Catalog > Residential Controls < Systems Controls > SYSTXCCITC01-B > Documents > Marketing > Miscellaneous > Infinity SystemControl Dealer Logo Application - Instructions.

Touch **DEALER LOGO** to upload the dealer logo and contact information from a micro SD card connected to the Infinity System Control. The “Dealer Logo Application” PC/MAC Desktop application download available at www.MyInfinityTouch.Carrier.com/Infinity/downloads is required to properly format the dealer logo and contact information for use on the wall control.

Along with the dealer logo (if any), three lines of dealer information are provided on the wall control:

Dealer name (50 characters, max)

Dealer phone number (20 characters, max)

Dealer URL (50 characters, max)

The wall control dealer information display is 30 characters wide. Dealer names and URLs over 30 characters will be split into two lines on the display.

The PC/MAC Desktop application to format the dealer logo and contact information can be found at:

www.MyInfinityTouch.Carrier.com/Infinity/downloads

Download the program and follow the program instructions.

Once the dealer logo and contact information have been properly loaded onto the micro SD card, insert the micro SD card into the bottom edge of the Infinity System Control. The control will prompt you whether or not to upload the dealer logo. Once complete, you will receive a confirmation that your upload was successful. If the information was not stored properly on the micro SD card, you will receive an error message that the dealer logo was not found. Refer back to the PC/MAC Desktop application instructions and try again. Once the upload is complete, touch **NEXT**.

If you have problems, contact your distributor service manager for support.

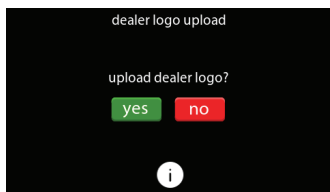
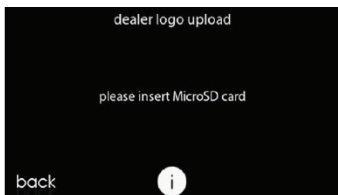

A170253

6.8. Utility Event Setup

The utility event setup is used to enable utility events if the home owner is participating in a utility event program. Selecting ON will enable the utility event icon on the main menu.

NOTE: See the Owner's Manual for additional details regarding the setup and configuration of the Utility Event feature.

7. Wireless Set-up

The Infinity System Control supports simultaneous connections to home Wi-Fi® networks. If the in-home Wi-Fi network is found to be incompatible with SYSTXCCITC01-B, another 2.4 GHz band wireless router can be installed to establish Wi-Fi network connectivity.

Please call 1-800-Carrier for support network with Wi-Fi network set-up and connection to the MyInfinity Server.

The ability to remotely access and adjust the settings of the Infinity System Control with the MyInfinity web and mobile applications is dependent on the compatibility of the user's computer/network or mobile device, the Infinity System Control, and/or the MyInfinity web server with, and the availability of, the user's Internet service provider or mobile device carrier service. Carrier Corporation makes no representations or warranties, express or implied, including, to the extent permitted by applicable law, any implied warranty of merchantability or fitness for a particular purpose or use, about the compatibility of the user's computer/network, or mobile device, with the Infinity System Control, and/or the MyInfinity web server, with, and the availability of, the user's Internet service provider or mobile device carrier service, or that the ability to remotely access and adjust the settings of the Infinity System Control will not be negatively affected by the network-related modifications, upgrades, or similar activity of the user's Internet service provider or mobile device carrier service.

NOTE: See the Owner's Manual for information regarding software upgrades.

7.1. Setup and Status Information (Homeowner's Router)

To establish Wi-Fi® connectivity to the Infinity System Control using the in-home router or wireless access point, the wireless access point SSID and password/passkey must be known for set-up.

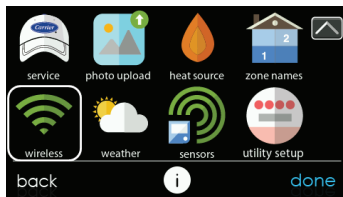

- Select **WIRELESS** from the menu screen.
- Make sure the Wi-Fi connection is enabled, by touching **ENABLED**.
- Touch **SETUP A WI-FI CONNECTION** to begin the process.
- Next, touch **SCAN FOR AVAILABLE ACCESS POINTS**.

A170241C



- On the next screen look for the SSID of the router. After being selected, it will be outlined in faint blue and indicated by a check mark. Then select **NEXT**. A13235



- The selected network will show. Choose an appropriate Wi-Fi network security mode. Usually auto-detect will correctly identify the type of security mode used. If the network has no security it will show as on the left, but a secured network will prompt for the Wi-Fi security key. A150175

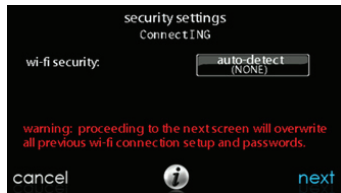

- If a Wi-Fi network security key is shown as on the right hand picture above then select the white bar and enter the security key, then select **NEXT**. A13237
- Touch in the security key area, and the keyboard will appear.
 - Use the on screen keyboard to enter the Wi-Fi network security key, then touch **NEXT**.
- The control will inform you if the connection is successful. If so, touch **DONE**.

- If the connection is unsuccessful, verify that the proper information has been entered before you touch **RETRY**. The control will go through the process again.



A13238

- After the control has connected to the network, go to www.MyInfinityTouch.Carrier.com to register the unit and begin remote access. This requires the MAC address and serial number of the Infinity System Control. To find the serial number and MAC address of the Infinity System Control, click on Menu, Down Arrow, Wireless and View MyInfinity Registration Info. This screen will provide the information needed on the MyInfinity website during registration.



A170285C

- If you have any issues, please contact your servicing dealer or contact the support desk at 1-800-Carrier.
- When the connection to the MyInfinity web server has been established, the status screen will show Connected for both Wi-Fi and the server.

Connected:

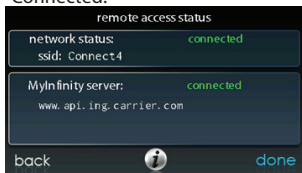

Not Connected:

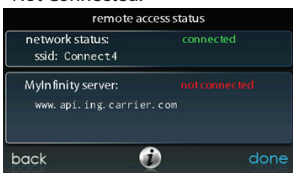

A13242C

⚠ WARNING

This product can expose you to chemicals including Lead and lead compounds, which are known to the State of California to cause cancer and birth defects or other reproductive harm. For more information go to www.P65Warnings.ca.gov

⚠ AVERTISSEMENT

Ce produit peut vous exposer à des agents chimiques, y compris le plomb et les composés de plomb, identifiés par l'Etat de Californie comme pouvant causer le cancer et des malformations congénitales ou autres troubles de l'appareil reproducteur. Pour de plus amples informations, prière de consulter www.P65Warnings.ca.gov

⚠ ADVERTENCIA

Este producto puede exponerlo a químicos que incluyen plomo y compuestos de plomo, los cuales son conocidos en el Estado de California como causantes de cáncer y defectos de nacimiento, u otros daños reproductivos. Para mayor información, visite www.P65Warnings.ca.gov



343824-201 REV.B

A180093

8. Wiring Diagrams

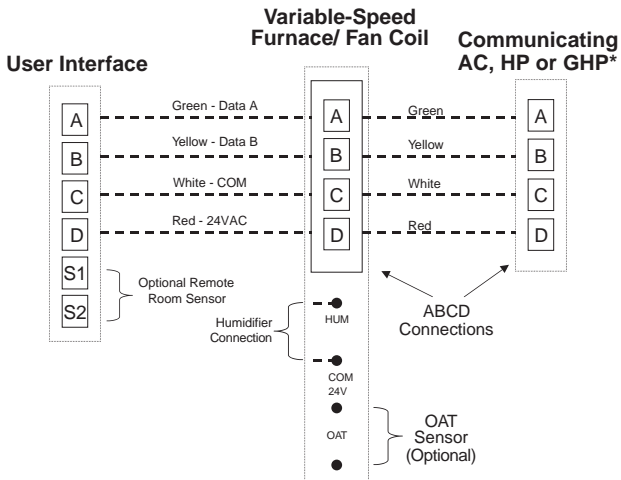

*NOTE: Some outdoor units do not require the "D" connections.
See outdoor unit Installation Instructions.

*NOTE: For SPP products, COM connection between Indoor and Outdoor controlboards are pre-wired at the factory.

*NOTE: For new SPP installations in which SENSE is required,
please refer to the SPP Installation Instructions.

Universal Four-Wire Connection

A160107

Variable-Speed Furnace/Fan Coil

User Interface

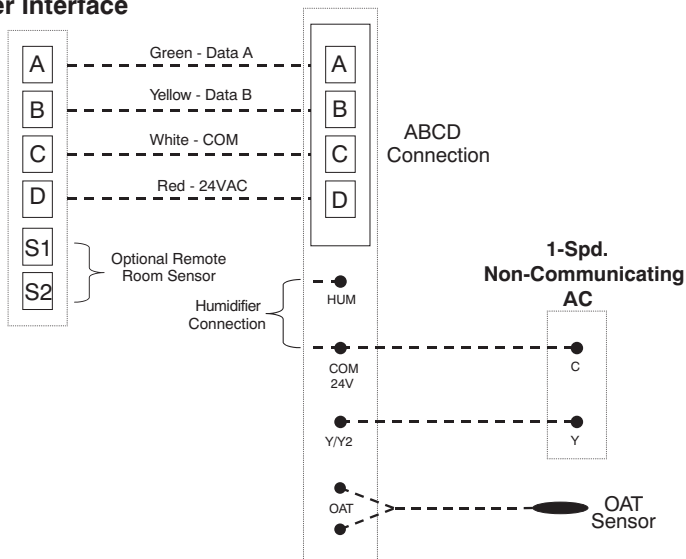

Connection Diagram for Furnace or FE Fan Coil with 1-Stage Air Conditioning

A12354

Variable-Speed Fan Coil

User Interface

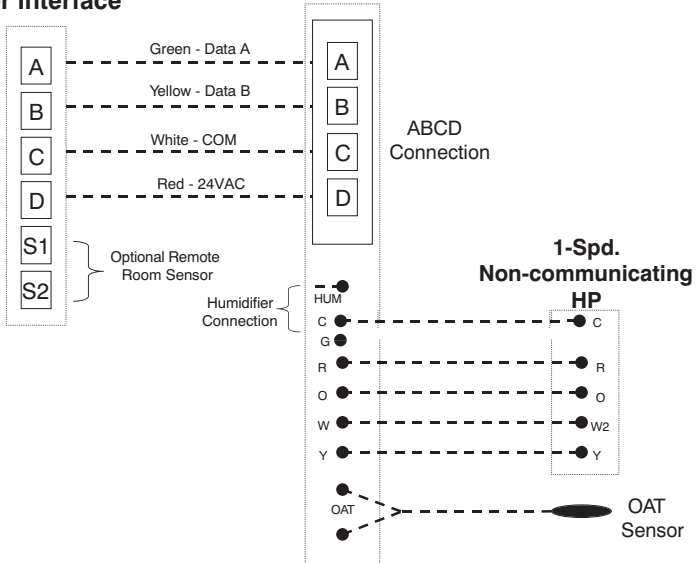

A12355

Connection Diagram for FE Fan Coil with Non-communication 1-Stage Heat Pump

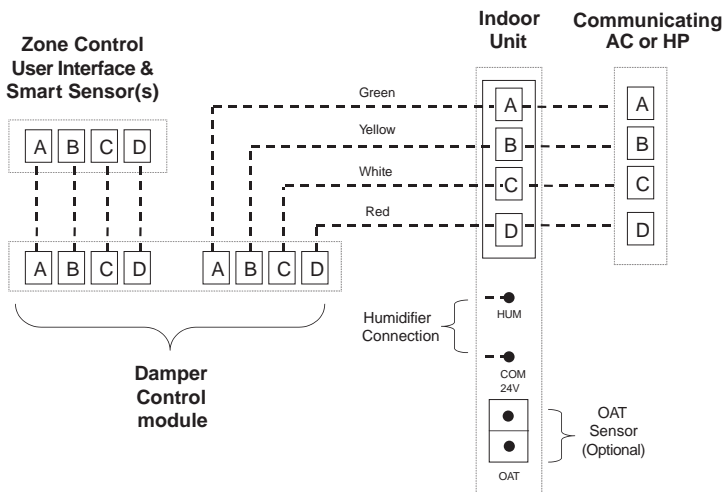

A04018

Zoning Connection for Communicating Indoor Unit with 2-Stage Communicating Outdoor Unit

NOTE: Some outdoor units do not require “C” and “D” connections. Please see outdoor unit Installation Instructions.

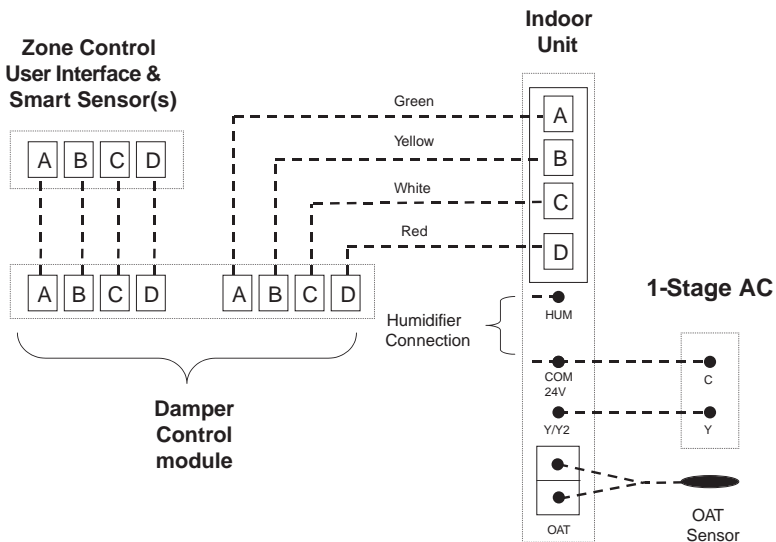

A04019

Zoning Connection Diagram for Furnace or FE Fan Coil with Non-Communicating 1-Stage Air Conditioning

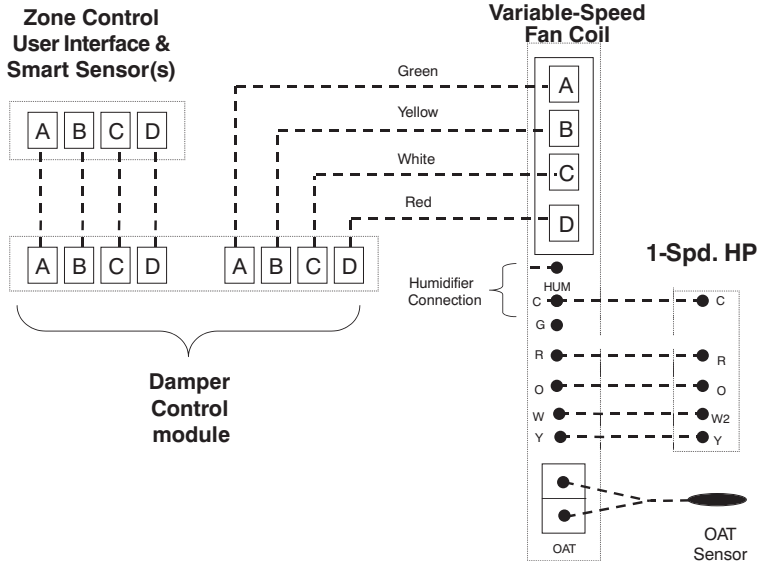

A07149

Zoning Connection Diagram for FE Fan Coil with Non-communicating 1-Stage Heat Pump

| IDU | Non-comm ODU | NIM required? |
|---------|--------------|---------------|
| Furnace | 1-stage A/C | No |
| Furnace | 2-stage A/C | Yes |
| Furnace | 1-stage HP | Yes |
| Furnace | 2-stage HP | Yes |

| | | |
|----------|-------------|-----|
| Fan Coil | 1-stage A/C | No |
| Fan Coil | 2-stage A/C | Yes |
| Fan Coil | 1-stage HP | No |
| Fan Coil | 2-stage HP | Yes |

A160170

NIM Chart

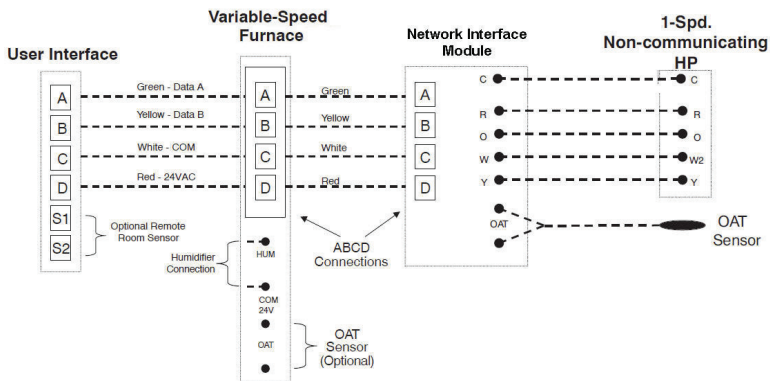

A160171

Wiring Diagram Single-Stage Non-Communicating Heat Pump NIM

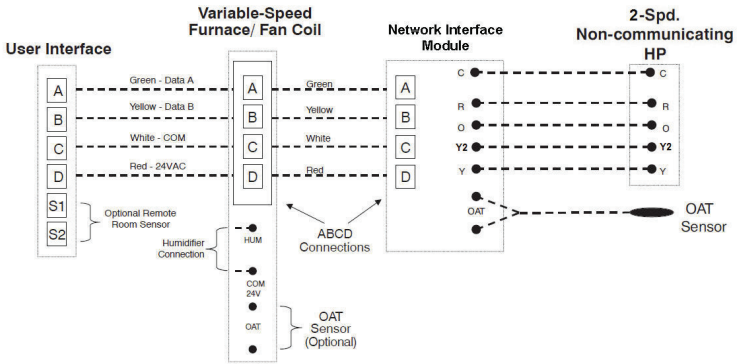

A160172

Wiring Diagram Two-Stage Non-Communicating Heat Pump NIM

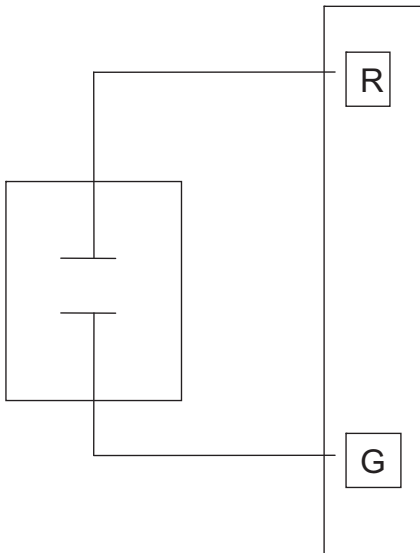

FE Fan Coil or
Variable Speed Furnace

G Input Wiring for Blower Operation

A07114

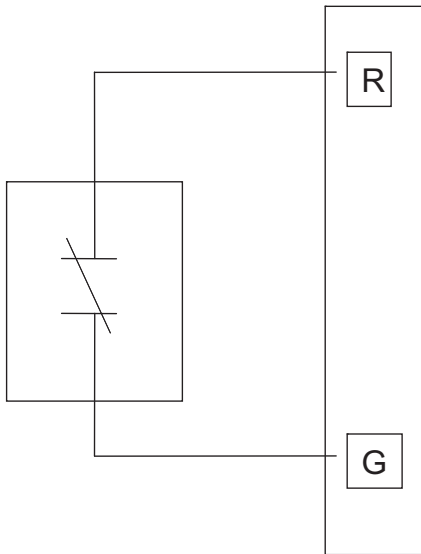

FE Fan Coil or
Variable Speed Furnace

A07115

G Input Wiring for System Shutdown

9. Statement Information

This device complies with Part 15 of the FCC Rules. Operation is subject to the following two conditions: (1) This device may not cause harmful interference, and (2) This device must accept any interference received, including interference that may cause undesired operation.

Changes or modifications not expressly approved by the party responsible for compliance could void the user's authority to operate the equipment.

9.1. FCC Interference Statement

This equipment has been tested and found to comply with the limits for a Class B digital device, pursuant to part 15 of the FCC Rules. These limits are designed to provide reasonable protection against harmful interference in a residential installation. This equipment generates, uses and can radiate radio frequency energy and, if not installed and used in accordance with the instructions, may cause harmful interference to radio communications. However, there is no guarantee that interference will not occur in a particular installation. If this equipment does cause harmful

interference to radio or television reception, which can be determined by turning the equipment off and on, the user is encouraged to try to correct the interference by one or more of the following measures:

- Reorient or relocate the receiving antenna.
- Increase the separation between the equipment and receiver.
- Connect the equipment into an outlet on a circuit different from that to which the receiver is connected.
- Consult the dealer or an experienced radio/TV technician for help.

To comply with FCC/IC RF exposure limits for general population / uncontrolled exposure, the antenna(s) used for this transmitter must be installed to provide a separation distance of at least 20 cm from all persons and must not be co-located or operating in conjunction with any other antenna or transmitter.

Pour se conformer aux limites d'exposition RF FCC et IC pour la population générale / l'exposition incontrôlée, l'antenne utilisée pour cet émetteur doit être installée pour assurer une distance de séparation d'au moins 20 cm de toutes les personnes et fonctionnant conjointement avec toute autre antenne ou émetteur.

This Device complies with Industry Canada License-exempt RSS standard(s). Operation is subject to the following two conditions: 1) this device may not cause interference, and 2) this device must accept any interference, including interference that may cause undesired operation of the device.

Cet appareil est conforme avec Industrie Canada, exempts de licence standard RSS (s). Son fonctionnement est soumis aux deux conditions suivantes: 1) ce dispositif ne peut pas causer d'interférences, et 2) ce dispositif doit accepter toute interférence, y compris les interférences qui peuvent causer un mauvais fonctionnement de l'appareil.

Infinity®, True Sense, Smart Evap, Côt and HYBRID HEAT® are trademarks or registered trademarks of Carrier Corporation in the United States and other countries. Other brands and product names are trademarks of their respective holders.

Wi-Fi® is a registered trademark of Wi-Fi Alliance Corporation.

Amazon Alexa is a trademark of Amazon, Inc. or its affiliates.

The Bluetooth word mark and logos are owned by Bluetooth SIG, Inc.



© 2020 Carrier. All rights reserved.

Catalog No: SYSTXCCITC-08SI 997-017060-8-R

Edition Date: 09/20 Replaces: SYSTXCCITC-07SI

Manufacturer reserves the right to change, at any time, specifications and designs without notice and without obligations.