

**25VNA8 Infinity® 18VS Variable Speed Heat Pump
 24VNA9 Infinity® 19VS Variable Speed Air Conditioner
 with Puron® Refrigerant**



Service Manual

TABLE OF CONTENTS

	PAGE
UNIT IDENTIFICATION	2
REFRIGERANT PIPING LENGTH LIMITATIONS	3
LONG LINE APPLICATIONS	3
SAFETY CONSIDERATIONS	4
GENERAL INFORMATION	4
ELECTRICAL	5
MAJOR COMPONENTS	5-7
AOC Board	5
Inverter	5
Variable Speed Compressor	5
Electronic Expansion Valve (EXP)	6
Outdoor Fan Motor	6
Pressure Transducer (SPT)	6
Pressure Equalizer Valve (PEV)	6
Outdoor Coil Thermistor (OCT)	6
Suction Thermistor (OST)	7
Discharge Thermistor (ODT)	7
Crankcase Heater	7
Time-Delays	7
COMMUNICATION AND STATUS FUNCTION LIGHTS	7
CHECK CHARGE	9
TROUBLESHOOTING	9-13
Service Tool	14-34
System Communication Failure	14
Model Plug	14
Status Codes	14
Variable Speed Compressor Winding Resistance	15
Fan Motor	16
Brown Out Protection	16
230v Line (Power Disconnect) Detection	16
Pressure Switch Protection	16
Suction Pressure Transducer (SPT)	16
Temperature Thermistors	17
Fault Code Action Table	19
Variable Speed Drive LED Location and Description	28
Compressor Power Harness Assembly Replacement	29
Inverter Assembly with Shield Gasket Installation	31
Compressor Replacement	34
WIRING DIAGRAMS	37-38
REFRIGERATION SYSTEM	39-43
Refrigerant	39
Compressor Oil	39
Servicing Systems on Roofs With Synthetic Materials	39
Brazing	39
Service Valves and Pump down	39
Liquid Line Filter Drier	42
Suction Line Filter Drier	42
Thermostatic Expansion Valve (TXV)	42
Accumulator	43
REFRIGERATION SYSTEM REPAIR	43

UNIT IDENTIFICATION

The unit is identified using a 16 digit model number structure. It is recommended providing the complete 16 digit model number when ordering replacement parts to insure receiving the correct parts.

MODEL NUMBER NOMENCLATURE - HEAT PUMP

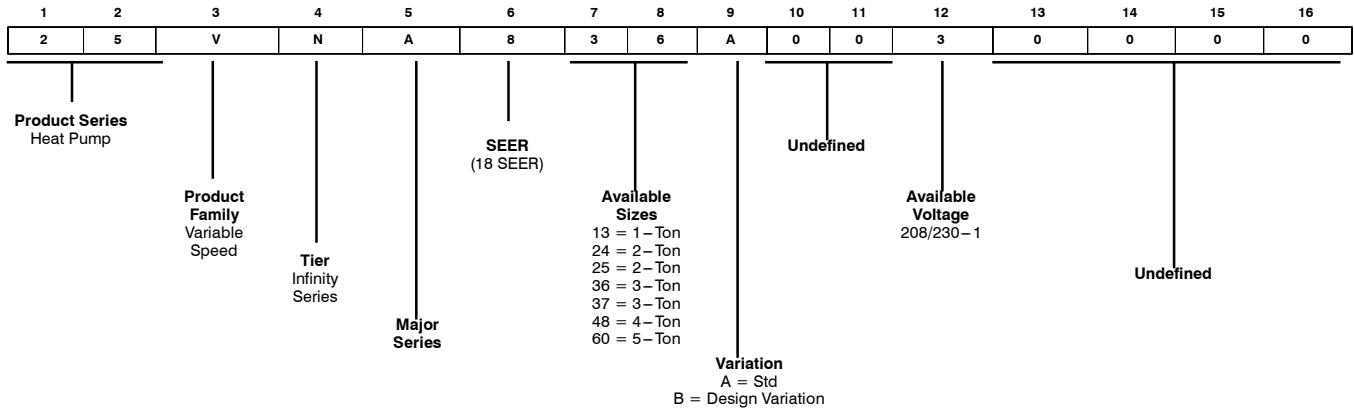

MODEL NUMBER NOMENCLATURE - AIR CONDITIONER

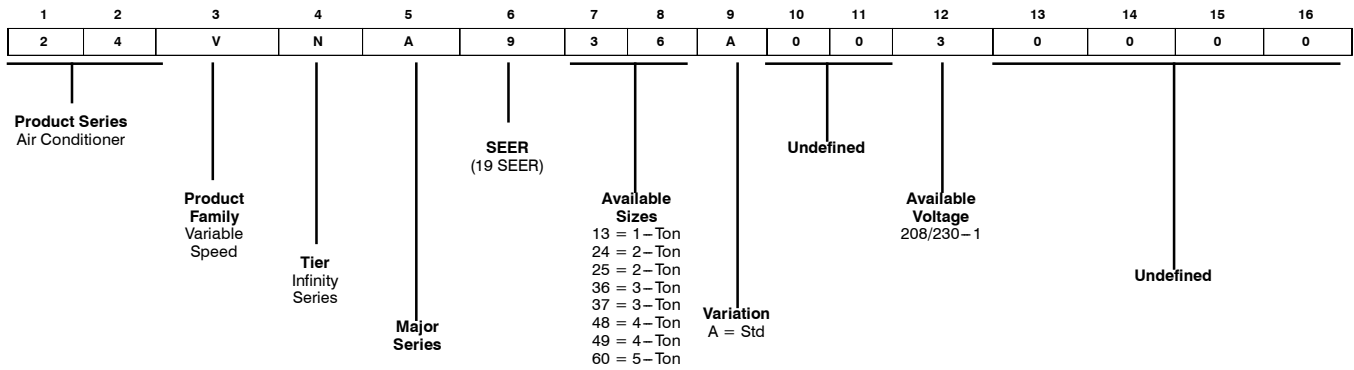

SERIAL NUMBER NOMENCLATURE

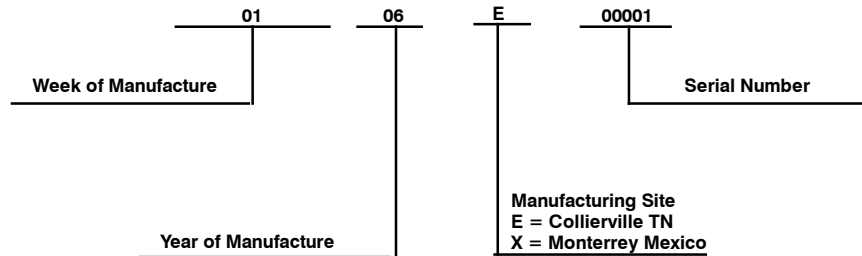

REFRIGERANT PIPING LENGTH LIMITATIONS

Maximum Line Lengths:

The maximum allowable total equivalent length varies depending on the vertical separation. See the tables below for allowable lengths depending on whether the outdoor unit is on the same level, above or below the outdoor unit.

Maximum Line Lengths

	MAXIMUM ACTUAL LENGTH ft (m)	MAXIMUM EQUIVALENT LENGTH† ft (m)	MAXIMUM VERTICAL SEPARATION ft (m)
Units on equal level	100 (30.5)	100 (30.5)	N/A
Outdoor unit ABOVE indoor unit	100 (30.5)	100 (30.5)	100 (30.5)
Outdoor unit BELOW indoor unit	See Table 'Maximum Total Equivalent Length: Outdoor Unit BELOW Indoor Unit'		

† Total equivalent length accounts for losses due to elbows or fitting. See the Long Line Guideline for details.

Maximum Total Equivalent Length† - Outdoor Unit BELOW Indoor Unit

Size	Liquid Line Diameter w/ TXV	AC / HP with Puron® Refrigerant – Maximum Total Equivalent Length† Vertical Separation ft (m) Outdoor unit BELOW indoor unit;						
		0–20 (0 – 6.1)	21–30 (6.4 – 9.1)	31–40 (9.4 – 12.2)	41–50 (12.5 – 15.2)	51–60 (15.5 – 18.3)	61–70 (18.6 – 21.3)	71–80 (21.6 – 24.4)
1–Ton	3/8	100*	100*	100*	100*	100*	100*	100*
2–Ton	3/8	100*	100*	100*	100*	100*	100*	100*
3–Ton	3/8	100*	100*	100*	100*	100*	100*	100*
4–Ton	3/8	100*	100*	100*	100*	100	100	--
5–Ton	3/8	100*	100*	100*	100*	100	100	--

* Maximum actual length not to exceed 100 ft (30.5 m)

† Total equivalent length accounts for losses due to elbows or fitting.

-- = outside acceptable range

LONG LINE APPLICATIONS

Unit is approved for up to 100 ft (30.5 m) equivalent length and vertical separations shown above with no additional accessories.

Longer line set applications are not permitted.

SAFETY CONSIDERATIONS

Installation, service, and repair of these units should be attempted only by trained service technicians familiar with standard service instruction and training material.

All equipment should be installed in accordance with accepted practices and unit Installation Instructions, and in compliance with all national and local codes. Power should be turned off when servicing or repairing electrical components. Extreme caution should be observed when troubleshooting electrical components with power on. Observe all warning notices posted on equipment and in instructions or manuals.

WARNING

ELECTRICAL HAZARD - HIGH VOLTAGE!

Failure to follow this warning could result in personal injury or death.

Electrical components may hold charge. DO NOT remove control box cover for 2 minutes after power has been removed from unit.

PRIOR TO TOUCHING ELECTRICAL COMPONENTS:

Verify zero (0) voltage at inverter connections shown on inverter cover.

WARNING

ELECTRICAL SHOCK HAZARD

Failure to follow this warning could result in personal injury or death.

Before installing, modifying, or servicing system, main electrical disconnect switch must be in the OFF position. There may be more than 1 disconnect switch. Lock out and tag switch with a suitable warning label.

WARNING



EXPLOSION HAZARD

Failure to follow this warning could result in death, serious personal injury, and/or property damage.

Never use air or gases containing oxygen for leak testing or operating refrigerant compressors. Pressurized mixtures of air or gases containing oxygen can lead to an explosion.

WARNING

UNIT OPERATION AND SAFETY HAZARD

Failure to follow this warning could result in personal injury or equipment damage.

Puron® (R-410A) systems operate at higher pressures than standard R-22 systems. Do not use R-22 service equipment or components on Puron® equipment. Ensure service equipment is rated for Puron®.

CAUTION

CUT HAZARD

Failure to follow this caution may result in personal injury.

Sheet metal parts may have sharp edges or burrs. Use care and wear appropriate protective clothing and gloves when handling parts.

Refrigeration systems contain refrigerant under pressure. Extreme caution should be observed when handling refrigerants. Wear safety glasses and gloves to prevent personal injury. During normal system operations, some components are hot and can cause burns. Rotating fan blades can cause personal injury. Appropriate safety considerations are posted throughout this manual where potentially dangerous techniques are addressed.

If you do not understand any of the warnings, contact your product distributor for better interpretation of the warnings.

GENERAL INFORMATION

The 25VNA8 & 24VNA9 split system heat pump and air conditioners features a new outdoor cabinet design that uses a four-sided coil design to minimize the unit footprint and provide the best heat exchange taking full advantage of the latest variable speed technology.

The heart of the system is the Toshiba Carrier variable speed rotary compressor powered through the use of the variable speed drive (VSD) inverter control. Through the use of Puron refrigerant, compact ECM outdoor fan motor, VSD and variable speed scroll compressor, along with the new outdoor cabinet, the unit achieves a Seasonal Energy Efficiency Ratio (SEER) of up to 19 and up to 11 Heating Seasonal Performance Factor (HSPF).

To ensure ultimate comfort, these units should be combined with either the FE fan coil or Variable Speed Gas furnace controlled with a two wire communication Infinity Touch Control SYSTXCCITC01, SYSTXCCITW01 or SYSTXCCITN01 with version 11 software or newer. Version 12 software or newer required for model size 13. This combination will ensure achievement of comfort with the convenience of fingertip trouble shooting and diagnostic capability. These units can also use a standard, 2-stage or single-stage thermostat, for limited functionality. However, 1-ton models will require the use of an Infinity Control.

ELECTRICAL

⚠ WARNING

ELECTRICAL SHOCK HAZARD

Failure to follow this warning could result in personal injury or death.

Exercise extreme caution when working on any electrical components. Shut off all power to system prior to troubleshooting. Some troubleshooting techniques require power to remain on. In these instances, exercise extreme caution to avoid danger of electrical shock. **ONLY TRAINED SERVICE PERSONNEL SHOULD PERFORM ELECTRICAL TROUBLESHOOTING.**

Aluminum Wire

⚠ CAUTION

UNIT OPERATION AND SAFETY HAZARD

Failure to follow this caution may result in equipment damage or improper operation.

Aluminum wire may be used in the branch circuit (such as the circuit between the main and unit disconnect), but only copper wire may be used between the unit disconnect and the unit.

Whenever aluminum wire is used in branch circuit wiring with this unit, adhere to the following recommendations.

Connections must be made in accordance with the National Electrical Code (NEC), using connectors approved for aluminum wire. The connectors must be UL approved (marked Al/Cu with the UL symbol) for the application and wire size. The wire size selected must have a current capacity not less than that of the copper wire specified, and must not create a voltage drop between service panel and unit in excess of 2 of unit rated voltage. To prepare wire before installing connector, all aluminum wire must be “brush-scratched” and coated with a corrosion inhibitor such as Pentrox A. When it is suspected that connection will be exposed to moisture, it is very important to cover entire connection completely to prevent an electrochemical action that will cause connection to fail very quickly. Do not reduce effective size of wire, such as cutting off strands so that wire will fit a connector. Proper size connectors should be used. Check all factory and field electrical connections for tightness. This should also be done after unit has reached operating temperatures, especially if aluminum conductors are used.

Unit Electrical Power

Power wires from the unit’s disconnect should be routed through the power wiring hole provided at the bottom of the unit’s control box.

Connect the ground wire to the ground connection in the control box and connect the power wiring to the terminal block as shown on the wiring and Installation Instructions supplied with the unit. The unit does not require a contactor or outdoor unit transformer in order to operate.

MAJOR COMPONENTS

Application Operational Control Board (AOC)



A160120

Fig. 1 – AOC (Application Operational Control) Board

The AOC board is located in the lower right hand side of inverter tray. It’s functions include:

- Compressor speed control
- Outdoor fan motor control
- Reversing valve operation
- Defrost operation
- Crankcase heater operation
- Pressure switch monitoring
- Time Delays
- Pressure Transducer measurements
- PEV control (pressure equalizer valve)
- Temperature measurements
- EXV (Electronic Expansion Valve) operation control
- Inverter communication and control

Inverter

The inverter is located inside the control box. This is an air-cooled device that communicates with the control board and drives the compressor and fan motor to the demanded RPM. The inverter is always powered with line voltage since no contactor is used. The inverter changes the line voltage to DC volts and then recreates 3 phase sine waves that vary in frequency to drive the compressor and fan motor at the desired RPM.

NOTE: The unit may be operated with an Infinity Touch Control or a standard 2-stage HP thermostat. However, 1-ton models will require the use of an Infinity Control. Infinity Touch Control will utilize 5 stages of heating and cooling, while 2-stage HP thermostat will only allow 2 discrete stages of heating and cooling operation.

Variable Speed Compressor

This unit contains a variable speed rotary compressor that has a wide operating range. It operates on a variable 3 phase sine wave provided by the inverter. This compressor can only be operated by the specific inverter supplied with the unit.

⚠ CAUTION

EQUIPMENT DAMAGE HAZARD

Failure to follow this caution may result in equipment damage and/or improper operation.

Do not attempt to apply line voltage directly to the compressor. This will destroy the compressor.

Electronic Expansion Valve (EXV)

This unit uses an electronic expansion valve for refrigerant metering in the heating mode. The control board drives the EXV to its proper position based on the operating mode and conditions. The Infinity Touch Control Service mode allows for manual opening and closing of the EXV for troubleshooting and pump down.

Outdoor Fan Motor

The compact ECM outdoor fan motor is a variable-speed brushless DC (BLDC) motor that operates at speeds from 400 to 1050 RPM. The motor is a 3-phase permanent magnet-type motor. Just like the compressor, this motor speed is determined by the inverter output frequency and amplitude.

Motor speed is controlled through the inverter board in the outdoor unit and no electronic module is attached. Motor speed is slowed as the building load decreases, maintaining the proper condensing temperature for both cooling and dehumidification. As the building load increases, the motor will increase speed until it is at maximum speed at the maximum building load.

At unit start-up, there is a slight delay and thrust motion of the fan motor/blade in the reverse direction, prior to ramping-up the fan assembly.

Pressure Transducer (SPT)

A 5 VDC output low pressure transducer that provides a 0-5 VDC data for interpretation by the control board for a 0 to 200 psig range of pressure at the suction tube. This interpreted pressure data is then intelligently used by the AOC control board for low pressure cut-out, loss of charge management, compressor protection, oil circulation management, lubrication management and EXV control.

Pressure Equalizer Valve (PEV)

At the end of every compressor operation (after the 3.5 minute Time Guard period), the equalizer valve opens for 150 seconds plus an additional 15 seconds of protection before allowing the compressor to start ramping up.

The PEV is located next to the suction and discharge of the compressor. The function of this valve is to prevent the compressor from starting with a high refrigerant pressure differential, thus helping the reliability of the compressor.

NOTE: A hissing sound may be heard during the equalization process. This is normal.

Outdoor Coil Thermistor (OCT)

The outdoor coil thermistor is a 10Kohm resistor used for multiple system operations. It provides the coil/liquid line temperature to the heat pump board and user interface. Low ambient operation, defrost initiation, defrost termination and assistance with OAT temperature measurement of some of the functions (see Fig.4) . The sensor must be securely mounted to the tube connecting the EXV and distributor. See Fig. 2 and Fig. 3 for proper placement. See Table 5 for proper resistances.

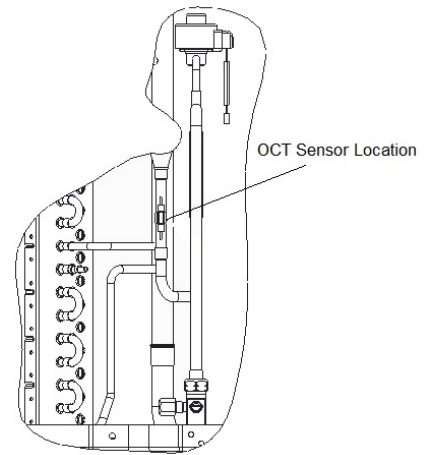

A14302

Fig. 2 – HP Outdoor Coil Thermistor (OCT) Attachment (On Distributor Tube)

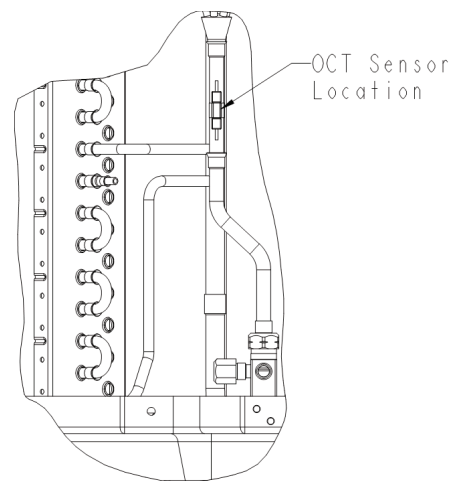

A14328

Fig. 3 – AC Outdoor Coil Thermistor (OCT) Attachment (On Distributor Tube)

OAT Thermistor must be locked in place with spherical nib end facing towards the front of the control box

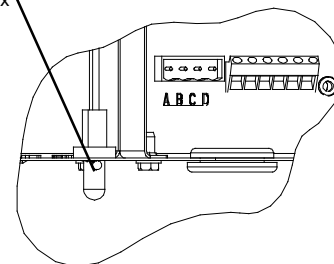

A11142

Fig. 4 – OAT Thermistor Location (Bottom of Control Box)

Suction Thermistor (OST)

Suction Thermistor is used for assisting in EXV control and must be secured on the suction tube and aligned longitudinally to the vertical surface of the tube axis (see Fig. 5).

⚠ CAUTION

UNIT DAMAGE HAZARD

Failure to follow this caution may result in equipment damage or improper operation.

In order to minimize the ambient influence, make sure the thermistor curved surface hugs the pipe surface and is secured tight using the wire tie fished through the original slot insulating polymer body.

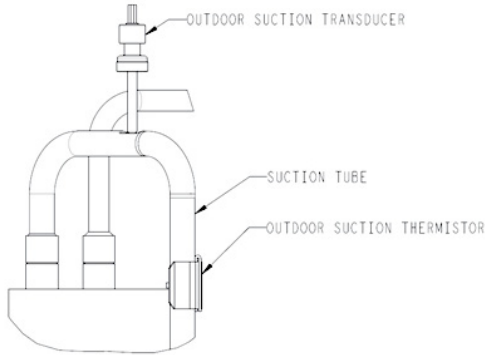

A14023

**Fig. 5 – Suction Thermistor (OST) Attachment
(On Suction Tube)**

Discharge Thermistor (ODT)

Discharge Thermistor is used for protection against over temperature of the compressor. The ODT is located on the compressor discharge stub-out (see Fig. 6).

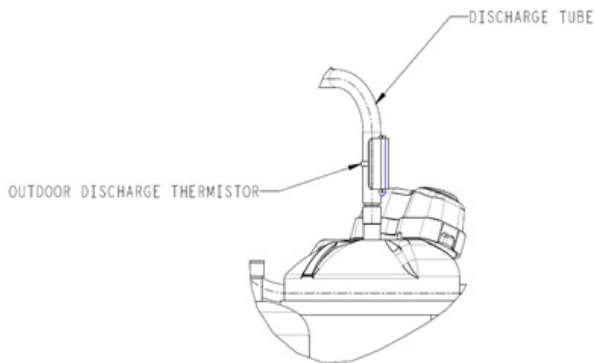

A14024

Fig. 6 – Discharge Thermistor (ODT)

Crankcase Heater Operation

This unit has an internal crankcase heater that will be energized during the off cycle and is intelligently demanded by the system to prevent the compressor from being the coldest part of the system thus enhancing the reliability. The crankcase heater will function as needed any time the outdoor unit is powered. The indoor unit and UI do not need to be installed for the crankcase heater to operate properly.

The compressor windings will occasionally be energized during the OFF cycle (depending on the length of the OFF cycle) to start the stator heat operation, thus maintaining a sump temperature that is essential for compressor reliability. The compressor will not run during this process.

Time Delays

The unit time delays include:

- 3.5 minute time delay after last cycle, initial power up, return from brown-out condition. To bypass this feature, momentarily short and release Forced Defrost pins.
- At the end of every compressor ON cycle, there will be 150 seconds of PEV open period for pressure equalization followed by 15 seconds of PEV Off period before the next compressor ON cycle. This delay cannot be bypassed as it helps compressor reliability.
- 15 second delay at termination of defrost before the auxiliary heat is de-energized.
- See Table 6 for other delay information.
- 10 minute sump warm-up delay. This delay is at the beginning of each high voltage power up.

COMMUNICATION AND STATUS FUNCTION LIGHTS

Infinity Touch Control, Green Communications (COMM) Light

A green LED (COMM light) on the outdoor board (see Fig. 7 and 8) indicates successful communication with the other system products. The green LED will remain OFF until communication is established. Once a valid command is received, the green LED will turn ON continuously. If no communication is received within 2 minutes, the LED will be turned OFF until the next valid communication. The green LED will be turned off when using a standard 2-stage non-communicating heat pump thermostat.

Amber Status Light

Amber colored **STATUS light** indicates operation and error status. See Table 6 for definitions.

- Two minute time delay to return to standby operation from last valid communication.

Defrost

This user interface (UI) offers 4 possible defrost interval times: 30, 60 and 90 minutes, or AUTO. The default is AUTO.

Defrost interval times: 30, 60, and 90 minutes or AUTO are selected by the Infinity Touch Control User Interface if using UI. The 90 minute selection will default to 60 minutes at ambient below 37 degrees. The UI setting will supersede the dip switch settings on the control board if not the same.

If using non-communicating thermostat, defrost intervals are set using dip switches on outdoor control board (see Fig. 7 and 8). AUTO defrosts adjusts the defrost interval time based on the last defrost time as follows:

- When defrost time <5 minutes, the next defrost interval=90 minutes. (outdoor temperature above 37°F)
- When defrost time 5-7 minutes, the next defrost interval=60 minutes.
- When defrost time >7 minutes, the next defrost interval=30 minutes.

The control board accumulates compressor run time. As the accumulated run time approaches the selected defrost interval time, the control board monitors the coil temperature sensor for a defrost demand. If a defrost demand exists, a defrost cycle will be initiated at the end of the selected time interval. A defrost demand exists when the coil temperature is at or below 32°F (0°C) for 4 minutes during the interval. If the coil temperature does not reach 32°F (0°C) within the interval, the interval timer will be reset and start over.

- Upon initial power up the first defrost interval is defaulted to 30 minutes. Remaining intervals are at selected times.
- Defrost is only allowed to occur below 50°F (10°C) outdoor ambient temperature.

The defrost cycle is terminated as described below.

- When OAT is > 25°F (+3.89°C), defrost terminates if outdoor coil temperature (OCT) > 60°F (+15.6°C). And a minimum of one (1) minute defrost length.
- When OAT ≤ 25°F (+3.89°C), defrost will terminate if OCT is >45°F (+4.4°C) and a minimum of 2 minutes defrost length.
- Or 10 minutes has passed.

At the defrost termination, the outdoor fan will turn on 10 seconds before the reversing valve switching.

NOTE: Compressor speed during defrost will go to defrost speed.

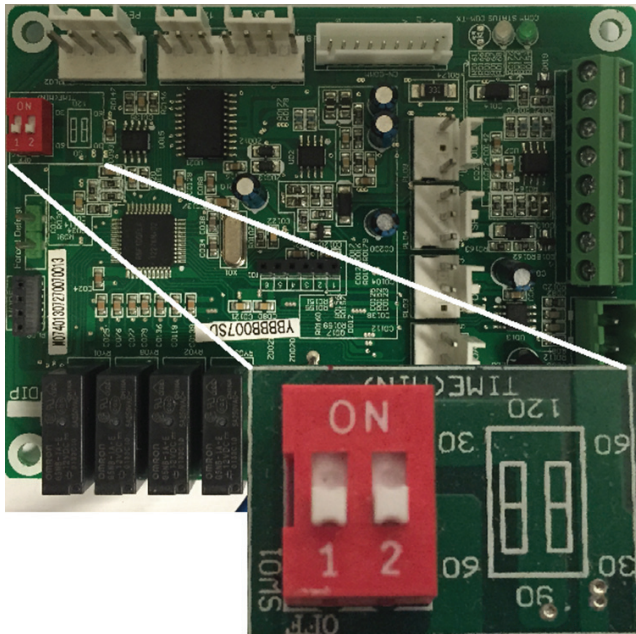

Fig. 7 – AOC Control Board for 1 and 2 Ton

A150034

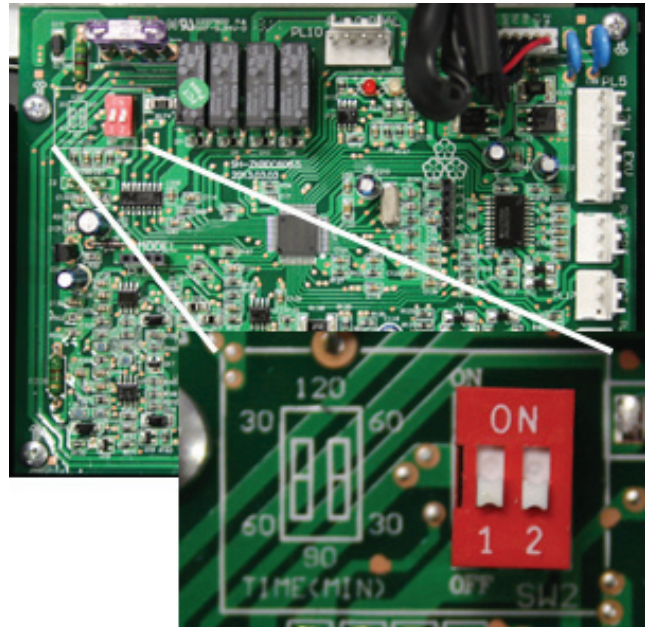

Fig. 8 – AOC Control Board for 3, 4 and 5 Ton

A14021

CHECK CHARGE

Charge in CHARGING mode (communicating only)

Unit is factory charged for 15ft (4.57 m) of lineset. If any refrigerant charge adjustment is required due to the user inputted line set length, the UI will calculate and display the target subcooling and the amount of additional charge to be added. Therefore, the UI is your source of information for charging the system correctly. Refrigerant charge adjustment amount for adding or removing 0.6 oz/ft (17.74 g/m) of 3/8 liquid line above or below 15ft (4.57 m) respectively. Perform a final charge check only when in cooling and OD is between 65°F (18°C) and 100°F (38°C).

The use of a commercial charge metering device (restrictor) such as Imperial liquid low side charger model 535-C or Watsco ChargeFaster model CH200 is recommended when adding refrigerant to an operating system. This prevents potential damage of liquid slugging of the compressor and allows the subcooling to stabilize quicker.

Charging using the subcooling method optimizes charge volume and is preferred if possible. If the outdoor temperature is between 65°F - 100°F (18.3°C - 37.8°C) and indoor temperature is 70°F - 80°F (21.1°C - 26.7°C), the option to further adjust charge using "service valve subcool" will be available in the "charging mode selection" screen. If temperatures are outside of range, this option will be greyed out and not selectable. Inaccurate charging may result in nuisance fault codes.

Initial start-up can be performed using calculated charge only and once conditions are within range, the "Service Valve Subcool" option will become selectable.

Once start is selected the system will operate in a preset mode until "done" is selected. Wait for required stabilization time then check subcooling at service valve.

Adjust charge as required to meet target service valve subcooling shown on screen -3/+0 degree. If any adjustment is necessary, add or remove the charge slowly (no greater than .5 lb per minute) and allow system to operate for 25 minutes to stabilize, before declaring a properly charged system.

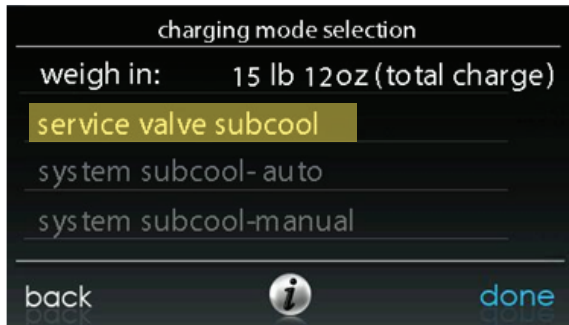

Fig. 9 – Adjusting Charge Using Service Valve Subcool

A14573



Fig. 10 – Service Valve Subcool Target Value

A14574



Fig. 11 – Stabilization Time

A14575

Charging Non-Communicating Systems

Charging Procedure: Force system to operate in high stage cooling by creating a large differential between room temperature and set point on thermostat. Use multi-meter to verify that 24 VAC is present between C, Y1 /Y2 terminals at outdoor unit.

Factory charge amount is shown on unit rating plate for high stage. Target subcooling chart is provided on back of control box door see Fig. 12 - 26 for example. To properly check or adjust charge, condition must be favorable for subcooling charging. Favorable conditions exist when outdoor temperature is between 65°F (18°C) and 100°F (38°C), and the indoor temperature is between 70°F (21°C) and 80°F (27°C). Follow the procedure below:

Unit is factory charged for 15ft (4.57 m) of lineset. Adjust charge by adding or removing 0.6 oz/ft (17.7 g/m) of 3/8 liquid line above or below 15ft (4.57 m) respectively.

For standard refrigerant line lengths (80ft/24.4 m or less), allow system to operate in cooling mode at least 25 minutes. If conditions are favorable, check system charge by subcooling method. If any adjustment is necessary, adjust charge slowly and allow system to operate for 25 minutes to stabilize before declaring a properly charged system.

If the indoor temperature is below 70°F (21.11°C), or the outdoor temperature is not in the favorable range, adjust charge for line set length above or below 15ft (4.57 m) and indoor fan coil /furnace coil per Table 1 and 2. Charge level should then be appropriate for the system to achieve rated capacity. The charge level should then be checked at another time when the both indoor and outdoor temperatures are in a more favorable range.

NOTE: If the line length is beyond 80ft (24.38 m) or greater than 20ft (6.10 m) vertical separation see Long line guideline for special charging requirement.

Table 1—Required Charge Adjustment for Indoor Coil Model - HP

Furnace or Fan Coil Model Number	Outdoor Model Size						
	13	24B	25	36	37	48	60
CNPV*18**	-	/	/	/	/	/	/
CAP**18**	-	/	/	/	/	/	/
CNP**24	-	/	/	/	/	/	/
CNPV*19**	-	/	/	/	/	/	/
CAP**24	-	/	/	/	/	/	/
CSPH*24	-	/	/	/	/	/	/
CSPH*30**	/	/	/	/	/	/	/
F(E,V)4(A,B,C)NF002	+0.19	-	-	-	-	/	/
CAP**30	/	-	/	/	/	/	/
CNP**30	/	-	/	/	/	/	/
CNP**36	/	-	-	-	-	/	/
F(E,V)4(A,B,C)N(B,F)003	/	-	-	-	-	/	/
CAP**36	/	-	-	-	-	/	/
CNP**42	/	+ .50	-	-	+ .75	/	/
CAP**42	/	+ .50	-	-	+ .75	/	/
CSPH*36	/	/	-	-	+ .75	/	/
CSPH*42**	/	/	+ .75	+ .75	+ .75	/	/
CNP**31**	/	/	+ .75	+ .75	+ .75	/	/
CNP**48	/	/	+ .75	+ .75	+ .75	-	/
CSPH*48**	/	/	+ .75	+ .75	+ 1.00	-	/
CNP**37	/	/	/	/	/	/	/
CNP**43	/	/	/	/	/	/	/
CAP**48	/	/	/	+ .75	+ 1.00	-	/
CNP**60	/	/	/	/	+ 1.00	-	-
CSPH*60	/	/	/	/	+ 1.00	-	-
F(E,V)4(A,B,C)N(B,F)005	/	/	+ .75	+ .75	+ 1.00	-	/
F(E,V)4(A,B,C)NB006	/	/	/	/	+ 1.00	+ 2.2	+ 1.00
CAP**60	/	/	/	/	/	+ 2.2	+ 1.00
CNP**61	/	/	/	/	/	/	/

/ = Comb. not allowed
 - = No charge adjust for ID

Table 2—Required Charge Adjustment for Indoor Coil Model - AC

Furnace or Fan Coil Model Number	Outdoor Model Size							
	13	24B	25	36	37	48	49	60
CNPV*18**	-	/	/	/	/	/	/	/
CAP**18**	-	/	/	/	/	/	/	/
CNP**24	-	-	-	/	/	/	/	/
CNPV*19**	-	/	/	/	/	/	/	/
CAP**24	-	-	-	/	/	/	/	/
CSPH*24	-	-	-	/	/	/	/	/
CSPH*30**	/	-	-	/	/	/	/	/
F(E,V)4(A,B,C)NF002	+0.19	-	-	-	/	/	/	/
CAP**30	/	-	-	/	/	/	/	/
CNP**30	/	-	-	/	/	/	/	/
CNP**36	/	-	-	-	-	/	/	/
F(E,V)4(A,B,C)N(B,F)003	/	-	-	-	-	/	/	/
CAP**36	/	-	+ .50	-	-	/	/	/
CNP**42	/	+ .50	+ .50	-	+ .75	/	/	/
CAP**42	/	+ .50	+ .50	-	+ .75	/	/	/
CSPH*36	/	+ .50	+ .50	-	+ .75	/	/	/
CSPH*42**	/	+ .50	+ .50	+ .75	+ .75	/	/	/
CNP**31**	/	+ .50	+ 1.25	+ .75	+ .75	/	/	/
CNP**48	/	+ .50	+ 1.25	+ .75	+ .75	-	-	/
CSPH*48**	/	+ .625	+ 1.25	+ .75	+ 1.00	-	-	/
CNP**37	/	+ .625	+ 1.25	+ .75	+ 1.00	-	-	/
CNP**43	/	+ .625	+ 1.25	+ .75	+ 1.00	-	-	/
CAP**48	/	/	/	+ .75	+ 1.00	-	-	/
CNP**60	/	/	/	/	+ 1.00	-	+ 0.125	-
CSPH*60	/	/	/	/	+ 1.00	-	+ 0.125	-
F(E,V)4(A,B,C)N(B,F)005	/	+ .625	+ 1.25	+ .75	+ 1.00	-	+ 0.125	/
F(E,V)4(A,B,C)NB006	/	/	/	+ .75	+ 1.00	+ 1.5	+ .625	+ 1.00
CAP**60	/	/	/	/	/	+ 1.5	+ .625	+ 1.00
CNP**61	/	/	/	/	/	+ 1.5	+ .625	+ 1.00

/ = Comb. not allowed
 - = No charge adjust for ID

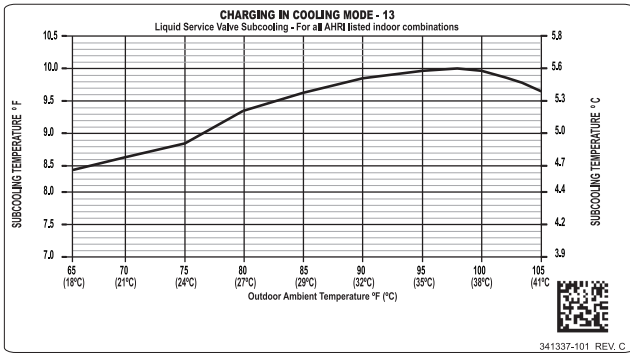

Fig. 12 – Charging in Cooling Mode 25VNA813

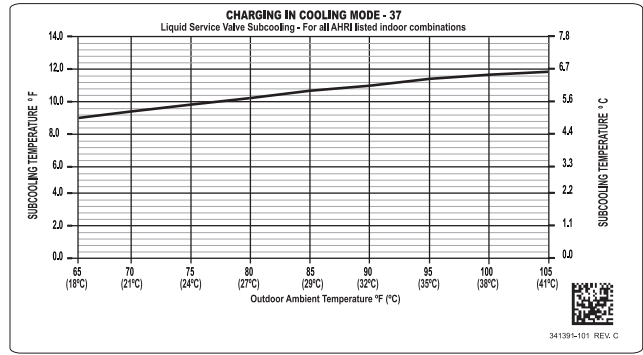

Fig. 16 – Charging in Cooling Mode 25VNA837

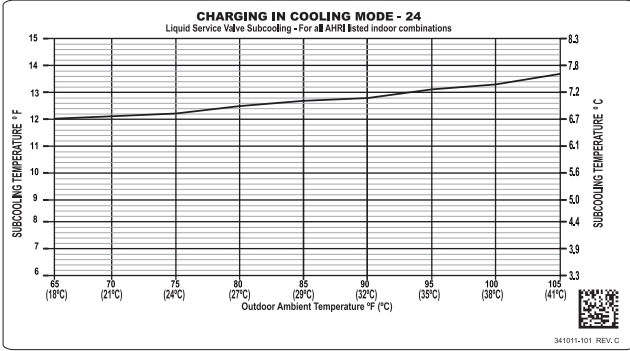

Fig. 13 – Charging in Cooling Mode 25VNA824

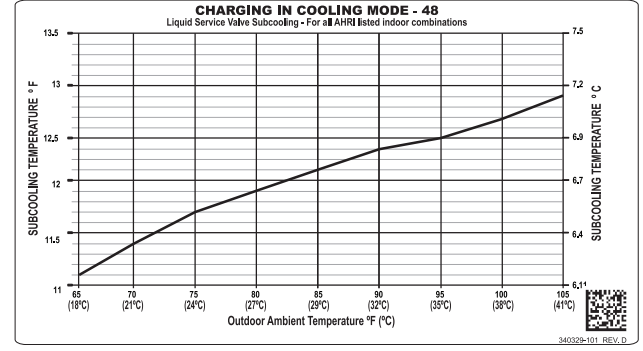

Fig. 17 – Charging in Cooling Mode 25VNA848

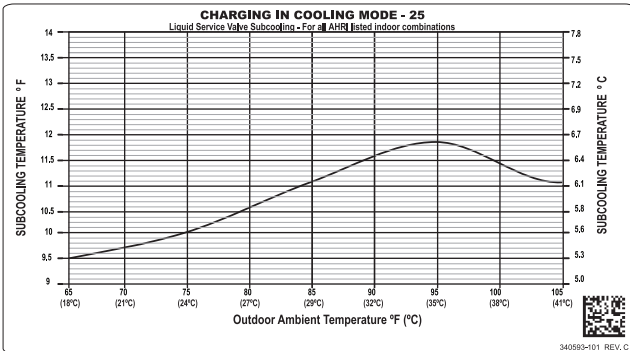

Fig. 14 – Charging in Cooling Mode 25VNA825

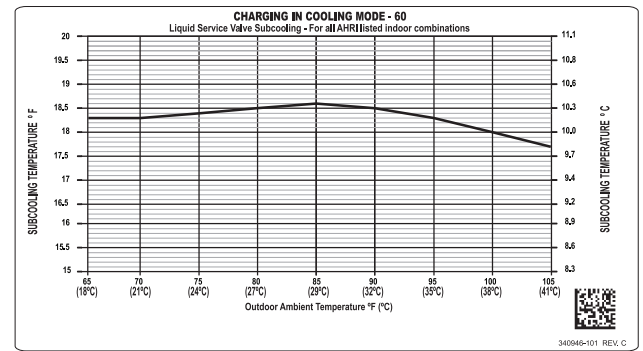

Fig. 18 – Charging in Cooling Mode 25VNA860

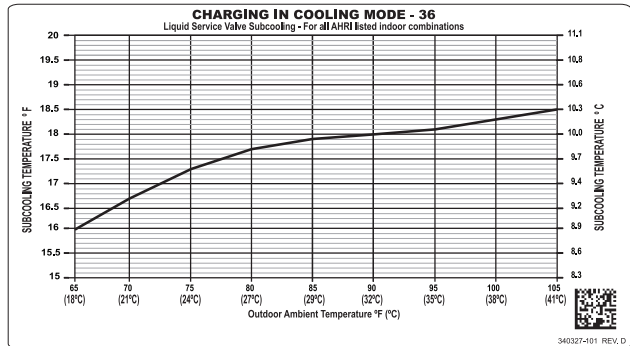

Fig. 15 – Charging in Cooling Mode 25VNA836

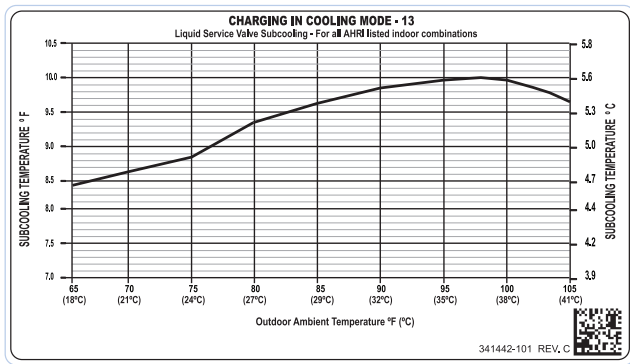

Fig. 19 – Charging in Cooling Mode 24VNA913

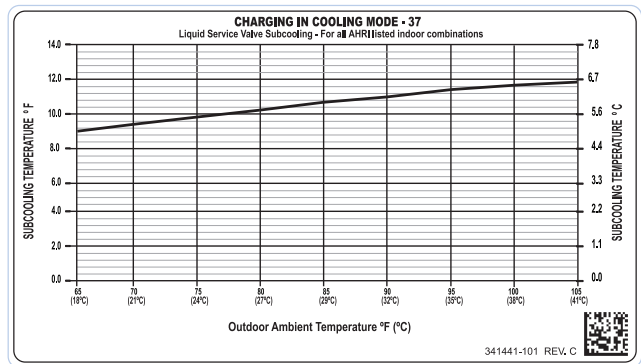

Fig. 23 – Charging in Cooling Mode 24VNA937

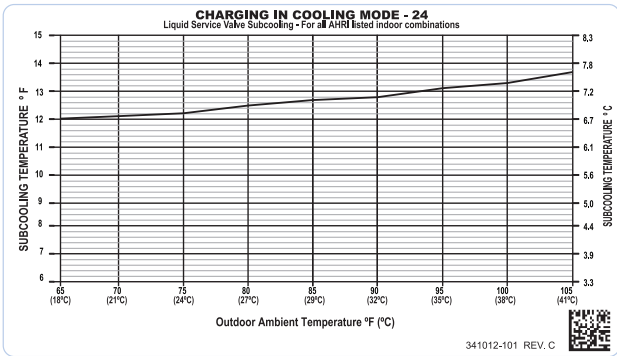

Fig. 20 – Charging in Cooling Mode 24VNA924B

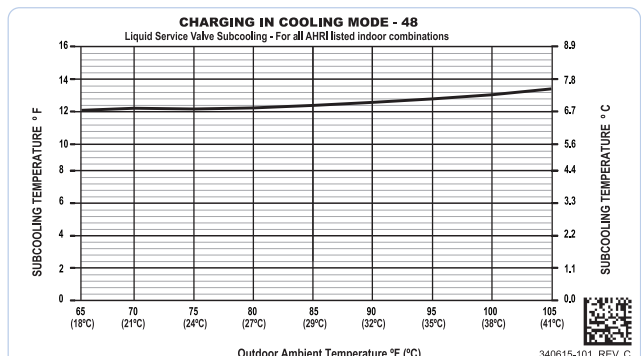

Fig. 24 – Charging in Cooling Mode 24VNA948

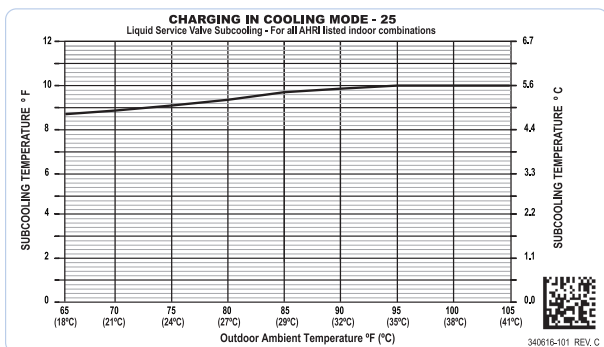

Fig. 21 – Charging in Cooling Mode 24VNA925

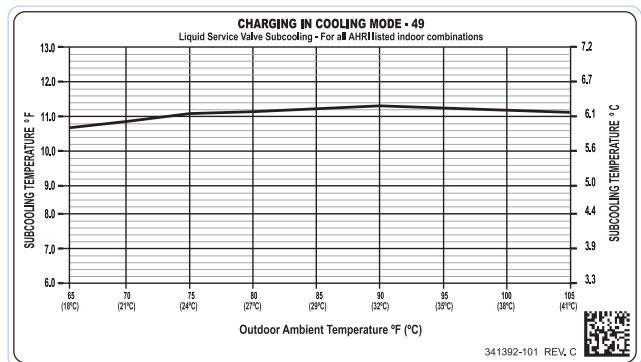

Fig. 25 – Charging in Cooling Mode 24VNA949

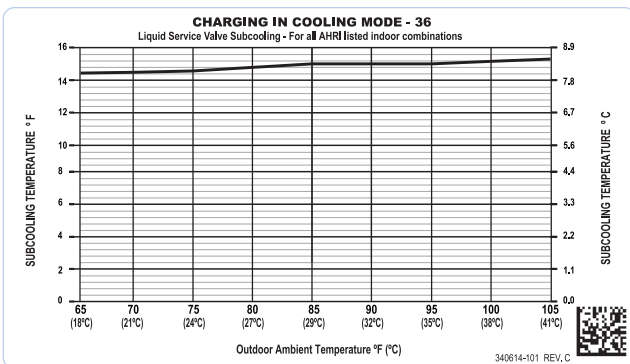

Fig. 22 – Charging in Cooling Mode 24VNA936

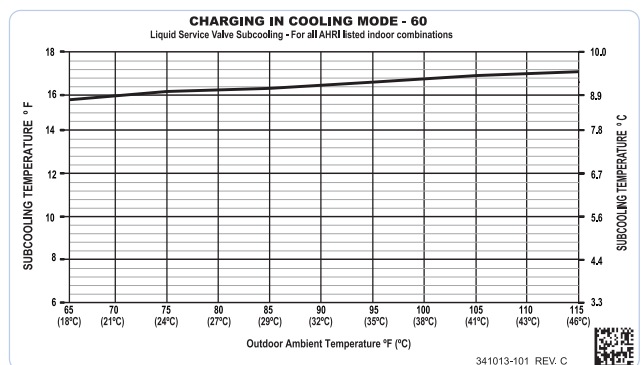

Fig. 26 – Charging in Cooling Mode 24VNA960

**Heating Check Chart Procedure (See Fig.27 - 33)
(Communicating / Non-communicating Systems)**

In heating mode, the required charging method is by weigh-in. On new installations or complete recharge, refer to the unit 0 and indoor fan coil / furnace coil per Table 1 for additional charge needed. Refrigerant charge adjustment amount for adding or removing 0.6 oz/ft (17.74 g/m) of 3/8 liquid line above or below 15ft (4.57 m) respectively.

Use the Defrost CHECKOUT mode to remove ice or frost from coil, if present, prior to checking the heating pressures.

To use the Heating Check Chart, the user interface (UI) must be in Refrigerant Charging mode selected from the Installation and Service screen. The Charging Mode Selection screen will show selections for Weigh-In Charge Method or Heating Check Charge Method. Select Heating Check Charge Method. The Heating Check Charge method will only be displayed if the conditions are right for checking the charge in heating mode. When Heating Check Charge Method is selected, the system will operate by running in stage 5 with appropriate outdoor fan speed and indoor airflow. Upon completion of a countdown period for system stabilization, check refrigerant pressures for the appropriate ambient temperatures shown in Fig. 27 through 33 based the OD unit size.

To use the Heating Check Chart in non-communicating systems, operate system at Y1+Y2-high stage. These charts indicate whether a correct relationship exists between system operating pressure and air temperature entering indoor and outdoor units. If pressure and temperature do not match on chart, system refrigerant charge may not be correct. **DO NOT USE CHART TO ADJUST REFRIGERANT CHARGE.**

NOTE: High pressure is at vapor service valve. Add 12 psig if high pressure is taken from liquid service valve.

NOTE: When charging is necessary during heating season, charge must be weighed in accordance with unit rating plate, ± 0.6 oz./ft (± 17.74 g/m). of 3/8-in. liquid-line above or below 15 ft (4.57 m), respectively.

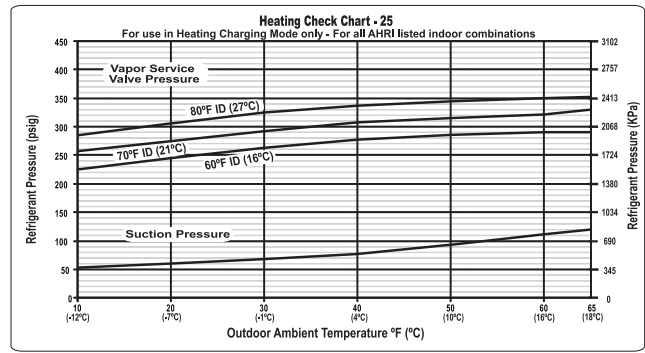

Fig. 29 – Heating Pressure Check Chart 25VNA825

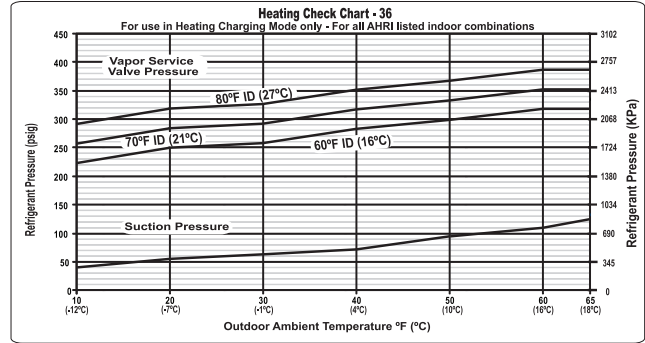

Fig. 30 – Heating Pressure Check Chart 25VNA836

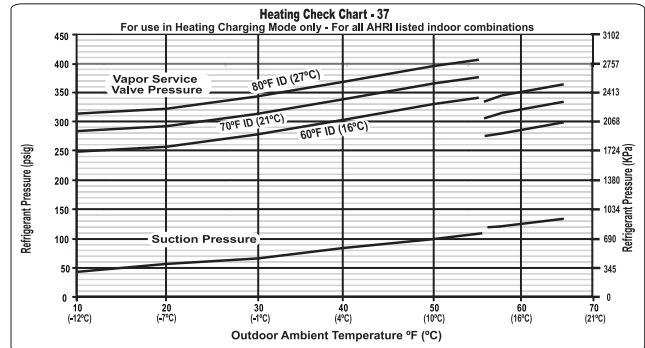

Fig. 31 – Heating Pressure Check Chart 25VNA837

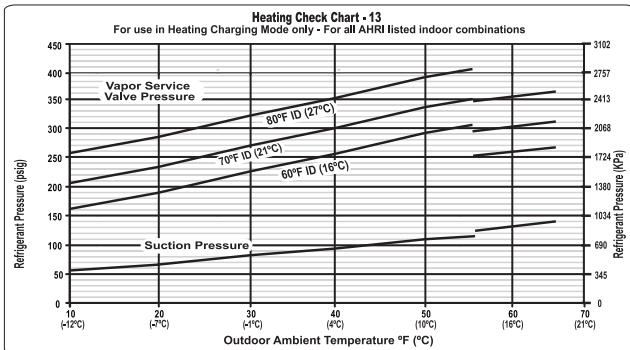

Fig. 27 – Heating Pressure Check Chart 25VNA813

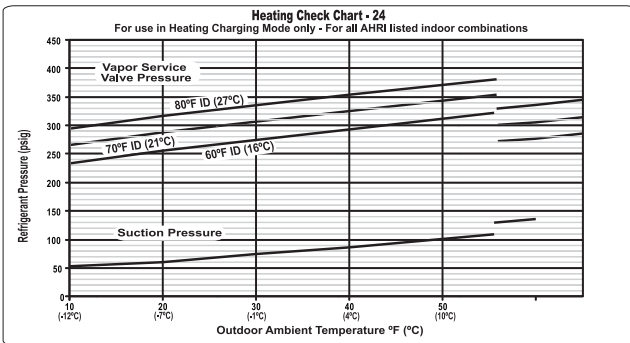

Fig. 28 – Heating Pressure Check Chart 25VNA824

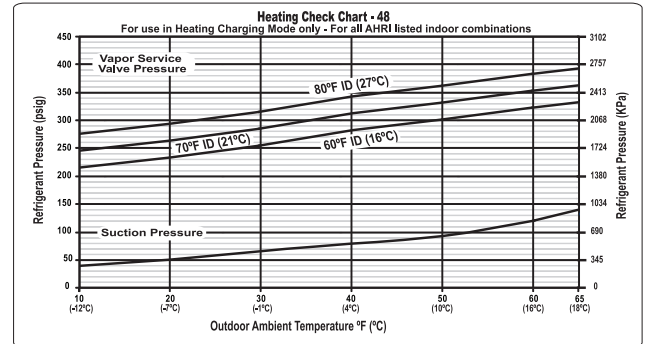

Fig. 32 – Heating Pressure Check Chart 25VNA848

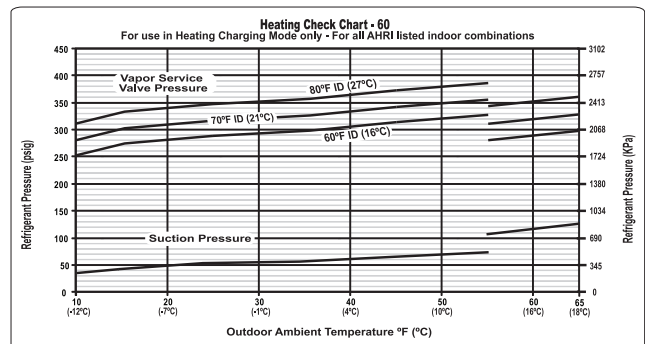
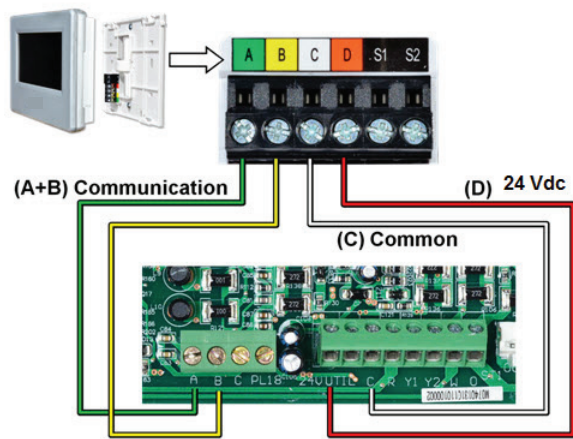

Fig. 33 – Heating Pressure Check Chart 25VNA860

TROUBLESHOOTING

Service Tool



A150062

Fig. 34 – Service Tool Connection

When working on the outdoor unit of a split system, the technician would usually need to repeatedly walk between the indoor wall control and the unit outside. To save time, the communicating controls offer a service tool feature.

By wiring the service tool into the AOC board and powering it with an external adapter, the technician can have a wall control capable of running the system right at the outdoor unit.

To use a service tool, connect the A and B communication bus wires from this second communicating control to the terminals marked A and B on the terminal strip located in the bottom left corner of the AOC board (see Fig. 34). But instead of connecting the wires on the service tool to the terminals marked C and D, connect the C and D wires from the service tool to the 24V and C on ST1 as shown in Fig. 34.

When the service tool is connected and powered up, the communicating controls inside the home will "go to sleep" and let the service tool take control of the system. In this manner, the service technician can run the diagnostic checkouts right at the outdoor unit using the service tool.

After the checkouts are completed and it is no longer necessary to use the service tool, remove it from the communicating controls and the indoor communicating controls will regain control in about two minutes.

Systems Communication Failure

If communication is lost with the User Interface (UI), the Green LED will be off. Check the wiring to the User Interface and the indoor and outdoor units and power.

Model Plug

Each control board contains a model plug. The correct model plug must be installed for the system to operate properly (see Table 3).

The model plug is used to identify the type and size of unit to the control.

On new units, the model and serial numbers are inputted into the AOC board's memory at the factory. If a model plug is lost or missing at initial installation, the unit will operate according to the information input at the factory and the appropriate error code will flash temporarily. An RCD replacement AOC board contains no model and serial information. If the factory control board fails, the model plug must be transferred from the original board to the replacement board for the unit to operate.

When installing heat pump with older fan coils, a model plug change may be required.

NOTE: The model plug takes priority over factory model information input at the factory. If the model plug is removed after initial power up, the unit will operate according to the last valid model plug installed, and flash the appropriate fault code temporarily.

Table 3—Factory Supplied Model Plug Information

25VNA8	MODEL PLUG NUMBER	Pins 1–4	Pins 2–3
13	HK70EZ029	11K	220K
24B	HK70EZ009	5.1K	91K
25	HK70EZ001	5.1K	11K
36	HK70EZ002	5.1K	18K
37	HK70EZ026	11K	120K
48	HK70EZ003	5.1K	24K
60	HK70EZ004	5.1K	33K

24VNA9	MODEL PLUG NUMBER	Pins 1–4	Pins 2–3
13	HK70EZ028	11K	180K
24B	HK70EZ010	5.1K	120K
25	HK70EZ011	5.1K	150K
36	HK70EZ012	5.1K	180K
37	HK70EZ025	11K	91K
48	HK70EZ013	5.1K	220K
49	HK70EZ027	11K	150K
60	HK70EZ014	5.1K	270K

Status Codes

⚠ ATTENTION

Unit may occasionally become unresponsive due to certain combinations of previous fault codes. There may not be anything wrong with the unit or components. The unit may require a high voltage power cycling for at least 2 minutes or longer to clear the condition. If the condition persists, conduct further troubleshooting per Service Manual.

Table 6 shows the status codes flashed by the amber status light. Most system problems can be diagnosed by reading the status code as flashed by the amber status light on the control board.

The codes are flashed by a series of short and long flashes of the status light. The short flashes indicate the first digit in the status code, followed by long flashes indicating the second digit of the error code.

The short flash is 0.25 seconds ON and the long flash is 1.0 second ON. Time between flashes is 0.25 seconds. Time between short flash and first long flash is 1.0 second. Time between code repeating is 2.5 seconds with LED OFF.

Codes are easily read from user interface (UI)

EXAMPLE:

3 short flashes followed by 2 long flashes indicates a 32 code. Table 6 shows this to be low pressure switch open.

Status Code Recall Mode

Active status codes are stored in memory even when power is absent. The most recent flashing status code (highest priority active) can be recalled from memory via Status Code Recall Mode and displayed using the amber LED. The Status Code Recall Mode is accessed by shorting (use a clip wire) the "force defrost" connector (labeled J2 on the board) and then power ON the unit.

Please make sure the unit is turned OFF before shorting the pins. Status Code Recall Mode will continue as long as the "force defrost" terminals remain shorted. The unit will not attempt to heat or cool while the terminals remain shorted. Once the status code is read, power-down the unit and remove the short.

Utility Interface With Infinity Touch Control

The utility curtailment relay should be wired between the two UTIL connections on the control board for this Infinity Communicating System (see Fig. 35). This input allows a power utility device to interrupt compressor operation during peak load periods. When the utility sends a signal to shut the system down, the User Interface status screen will display, "Curtailment Yes". See UI installation instructions for setup details.

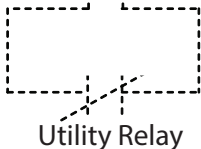
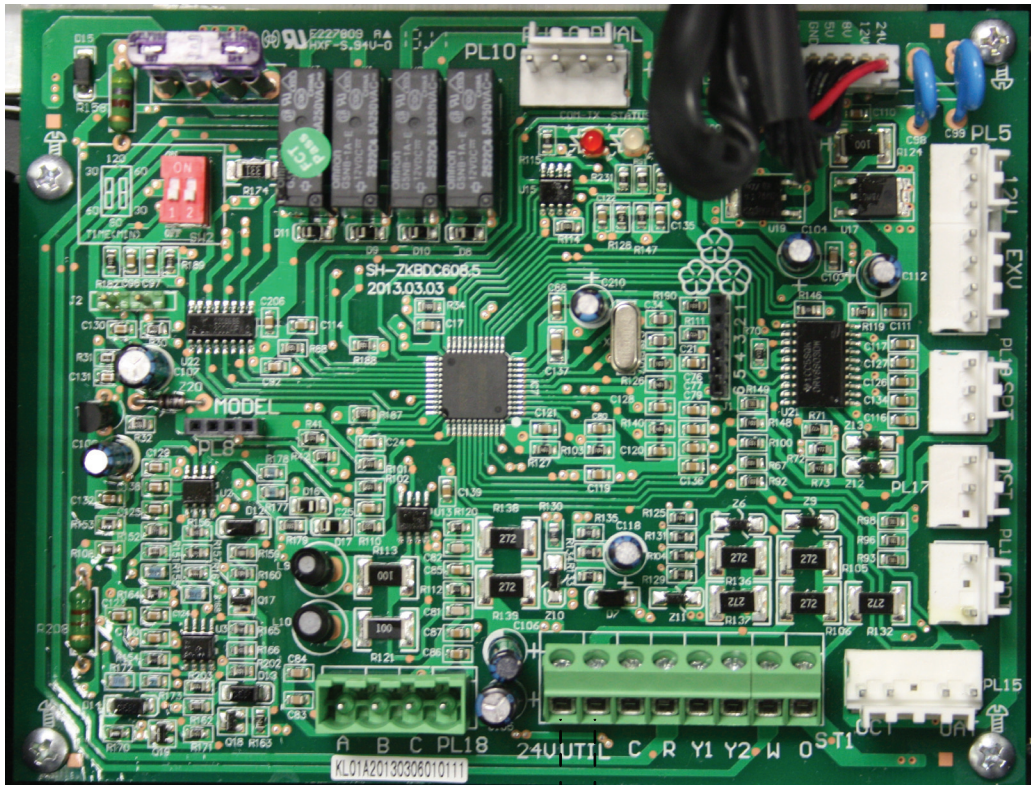

Fig. 35 – Variable Speed Control Board with optional Utility Relay

A13414

Variable Speed Compressor Winding Resistance

This compressor operates with 3-phase variable frequency PWM variable voltage. For troubleshooting certain fault codes related to compressor resistances, follow these steps:

1. Disconnect compressor power leads from the inverter MOC terminals, U (YEL), V (RED), and W (BLK).
2. Measure the resistance between YEL to RED, YEL to BLK, and RED to BLK and compare to Table 4 values. Each resistance set should be equal.
3. Measure the resistance to ground for each lead.
4. If the resistances check out, reconnect power leads to appropriate terminal.
5. If the resistances appear to be abnormal, it will be necessary to measure the resistance at the compressor fusite terminals.
6. During the removal of the compressor fusite cap, do not remove the RTV sealant. Remove the harness plug, measure the resistances, and compare to Table 4.
7. Special care will need to be taken with the replacement of the compressor fusite cap. Make sure the two holes in the compressor fusite terminal box are still full of RTV sealant before the cap is installed. The factory RTV can be reused as long as none of it has been removed during the cap removal.
8. Reinstall compressor sound blanket making sure discharge thermistor and compressor power harness are routed as they were from the factory

Table 4—Variable Speed Compressor Resistance (winding resistance at 70°F ± 20°F)

WINDING	MODEL 25VNA8 / 24VNA9 (OHMs)				
	13, 24B	25	36	37, 48	49, 60
Between terminals	1.13	.59	.59	.37	.24
Between terminal & ground	>1 mega				

⚠ CAUTION

UNIT DAMAGE HAZARD

Failure to follow this caution may result in equipment damage and/or improper operation.

Do not use Meggar for measuring the winding resistance.

⚠ CAUTION

UNIT DAMAGE HAZARD

Failure to follow this caution may result in equipment damage and/or improper operation.

To maintain water integrity of the compressor fusite terminal box, the two holes in outer ring need to be full of RTV sealant.

Fan Motor

If verification of proper operation is required for the fan motor used in this unit, follow these steps:

1. Disconnect fan motor connector from control board.
2. Measure resistance between any 2 of the 3 leads present.
3. Compare measurement to values below

Fan Motor Resistance	
Unit Size	Resistance (Ohms)
13, 24B	21.2
25, 36, 37, 48, 49 (AC), 60	11.1

Brown-Out Protection

If the line voltage is less than 187V for at least 4 seconds, the Compressor and OD fan goes to 0 rpm. Compressor and fan operation are not allowed until voltage is a minimum of 190V. The control will flash the appropriate fault code (see Table 6).

230V Line (Power Disconnect) Detection

The control board senses the presence of absence of 230V through inverter feedback. Voltage should present at all times when system is in service regardless if system is running or standby. If there is no 230V at the inverter when the indoor unit is powered with a cooling or heating demand, the appropriate fault code is displayed on UI (communicating only – see Fig. 39). If system is configured with conventional heat pump thermostat (non-communicating), no fault code will be displayed on AOC board, nor will any status LEDs be lit. Use multimeter to check for the presence of 230V in this situation.

High Pressure Switch Protection

The outdoor unit is equipped with a high pressure switch. If the control senses the opening of a high pressure switch (open 600+/-5 psig, close 470+/-10 psig @77°F), it will respond as follows:

1. Display the appropriate fault code (see Table. 6).
2. After a 6 minute delay, if there is a call for cooling or heating and HPS is reset, the PEV opens for 150 seconds to equalize system pressures. The compressor and fan will then ramp to the next lower stage of operation until demand is satisfied. The staging down and resetting to the highest stage will end after 2 hours of accumulated operation without further HPS trips.
3. A system malfunction will occur after repeated HPS faults and the stages have reached the lowest level. This could take five consecutive HPS trips if the first occurred in stage 5 demand or 1 HPS trip if in stage 1 demand.
4. In the event of a high-pressure switch trip or high-pressure lockout, check the refrigerant charge, outdoor fan operation, and outdoor coil (in cooling) for airflow restrictions, or indoor airflow in heating.

Low Pressure Protection

The outdoor unit is equipped with low pressure transducer. If the control senses a low pressure per the table below, it will respond as follows:

Cooling Low Pressure 3 minute operation	Cool mode resume operation begins	Low Pressure (No Operation)	Heating Low Pressure 5 minute operation	Heat mode resume operation begins
<= 33	> 43	<= 15	<= 33	> 35

1. Display the appropriate error code on the status LED (see Table 6).
2. If a demand persists after the 6-minute delay and the pressure has reached the operation level, then resume operation. Reset the 6 minute timer, clear the displayed error code and communicate cleared error to the User Interface. Status LED reverts to operation code display.
3. If a demand persists after the 6-minute delay but the pressure has not recovered, turn off the ODF. If the pressure recovers any time after the 6 minute delay, then resume operation. Reset the 6 minute timer, clear the displayed error code and communicate cleared error to the User Interface. Status LED reverts to operation code display.
4. If a pressure drops below the NO-operation level three (3) consecutive times, then lock out operation for 4 hours and flash the appropriate error code and communicate lockout status to the User Interface. The trip counter will reset to zero if 15 minutes of successful operation occurs before the 3rd trip is recorded. Record the low pressure lockout in the historical data.
5. In the event of a low pressure trip or low pressure lockout, check the refrigerant charge and indoor airflow (cooling) and outdoor fan operation and outdoor coil in heating.

Suction Pressure Transducer (SPT)

If the accuracy of the transducer is questioned, the technician can check it while it is attached to the AOC board. Connect a gage manifold to the suction valve gage port fitting.

At the AOC board, with the wire harness receptacle exposing a portion of the three pins on the AOC board, a DC voltmeter can read the DC voltage between ground and supply (input) terminal. Ensure that the input voltage is 5 VDC. Next, read the DC voltage across the ground and output terminal. Record the output voltage.

The suction pressure that the pressure transducer is reading can be calculated by taking the output voltage and subtracting 0.5 from it then taking that difference and multiplying it by 50. Pressure (psig) = 50.0 x (DCV out - 0.5). For example, if the measured voltage is 3.0 VDC: 50 X (3.0 - 0.5) = 50 X 2.5 = 125 psig. See Fig. 36.

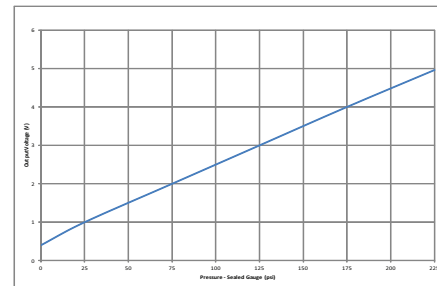

Fig. 36 – Suction Pressure Transducer (SPT) Output Function Graph

A12035

Temperature Thermistors

Thermistors are electronic devices which sense temperature. As the temperature increases, the resistance decreases. 10Kohm thermistors are used to sense outdoor air temperature (OAT), coil temperature (OCT) and the suction line temperature (OST) located between the reversing valve and the accumulator. A 50Kohm thermistor is used to sense discharge temperature (ODT).

Refer to Table 5 and Fig. 37 and 38 for resistance values versus temperature.

Table 5—10K/50Kohm Resistance Values vs Temperature

10Kohm °C (°F)	
TEMPERATURE	RESISTANCE (ohms)
25.0 (77.0)	10.0 + / - 2.3%
0.0 (32.0)	32.6 + / - 3.2%
-28.0 (-18.4)	85.5 + / - 3.4%
50Kohm	
125.0 (257.0)	1.7 + / - 1.6%
75.0 (167.0)	7.40 + / - 2.0%
25.0 (77.0)	50.0 + / - 2.3%

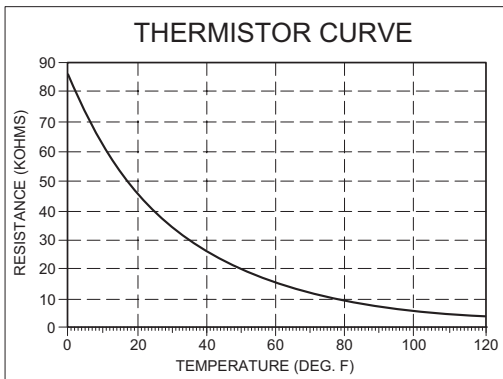

A91431

Fig. 37 – 10K Thermistor Resistance Versus Temperature

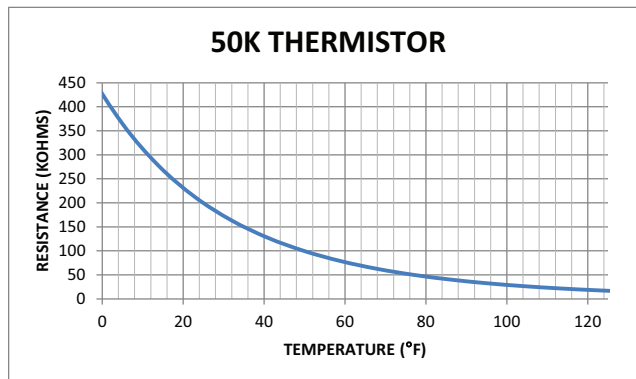

A14022

Fig. 38 – 50K Thermistor Resistance Versus Temperature

If the outdoor air or coil thermistor should fail, the control will flash the appropriate fault code (see Table 6).

IMPORTANT: The outdoor air thermistor, coil thermistor and suction thermistor should be factory mounted in the final locations. **Check to ensure thermistors are mounted properly (See Fig. 2, 3, 4, 5 and 6).**

Thermistor Sensor Comparison

The control continuously monitors and compares the outdoor air temperature sensor and outdoor coil temperature sensor to ensure proper operating conditions. The comparison is:

- In cooling if the outdoor air sensor indicates $\geq 10^{\circ}\text{F}$ ($\geq 5.6^{\circ}\text{C}$) warmer than the coil sensor (or) the outdoor air sensor indicates $\geq 25^{\circ}\text{F}$ ($\geq 15^{\circ}\text{C}$) cooler than the coil sensor, the sensors are out of range.
- In heating if the outdoor air sensor indicates $\geq 35^{\circ}\text{F}$ ($\geq 19.4^{\circ}\text{C}$) warmer than the coil sensor (or) the outdoor air sensor indicates $\geq 10^{\circ}\text{F}$ ($\geq 5.6^{\circ}\text{C}$) cooler than the coil sensor, the sensors are out of range.

If the sensors are out of range, the control will flash the appropriate fault code as shown in Table 6.

Failed Thermistor Default Operation

Factory defaults have been provided in the event of failure of outdoor air thermistor (OAT) and/or outdoor coil thermistor (OCT).

If the OAT sensor should fail, defrost will be initiated based on coil temperature and time.

If the OCT sensor should fail, defrost will occur at each time interval during heating operation, but will terminate after 2 minutes.

If there is a thermistor out-of-range error, defrost will occur at each time interval during heating operation, but will terminate after 2 minutes.

Count the number of short and long flashes to determine the appropriate flash code. Fig. 39 and Table 6 gives possible causes and actions related to each error.

Maximum Power Mode - Inverter Over Temperature

The outdoor unit is equipped with inverter temperature sensing. If the inverter senses a temperature above the high threshold limit it will respond as follows:

1. Display the local fault code only on the AOC Status LED.
2. The system will continue to run but attempt to mitigate by speed reduction.
3. When the system demand is satisfied, the unit will shut down.
4. If the fault is still active on the AOC Status LED, the ODF will continue to run at 500 RPM until the inverter temperature falls below the threshold.
5. The compressor will not restart if the fault is still active.

SERVICE			
AMBER LED DESCRIPTION	* FLASH CODE (Amber LED)	RESET TIME (Minimum) Minutes	** TYPE
Standby	ON, no flash	--	--
Variable Capacity Mode	1, pause	--	--
Variable Speed Range Cutback	1 (2 sec ON), longer pause (1 second OFF)	--	--
2-stage "LOW" Capacity	1, pause	--	--
2-stage "HIGH" Capacity	2, pause	--	--
2-stage "REDUCED" Capacity	4, pause	--	--
Invalid Model Plug/Inverter Size	25	N/A	System Malfunction
High Pressure Switch Open	31	6	Fault
Low Pressure Trip	32	6	Local
Lost Inverter Communications	33	6	Local
Brownout Event	46	6	Local
Lost Inverter Communications	48	6	System Malfunction
Compressor Over Current Fault	49	6	Local
Outdoor Air Temp Sensor Fault	53	N/A	Fault
Suction Temp Sensor Fault	54	N/A	Fault
Coil Temp Sensor Fault	55	N/A	Fault
OAT-OCT Thermistor Out of Range	56	N/A	Event
Suction Pressure Sensor Fault	57	N/A	Fault
Discharge Temperature Out of Range Event	59	15	Local
Fan Inverter Fault	61	6	Local
Fan Inverter Current Fault	63	6	Local
D C Voltage Low - SPD Limiting	65	N/A	Local
Outdoor Fan Dropped Out	66	6	Event
Stator Heater Fault	67	6	Event
10 Minute Stage 2 Warmup Delay	68	10	Event
Inverter / Compressor Internal Fault	69	15	System Malfunction
Compressor Dropped Out	71	6	Event
Suction Over Temperature Event	72	15	Local
Discharge Temp Out of Range Lockout	74	2 Hours	System Malfunction
Maximum Power Mode-Temp	75	N/A	Local
Fan Inverter Lockout	76	2 Hours	System Malfunction
Maximum Power Mode-Comp Current	77	N/A	Local
Compressor/Inverter Fault	79	6	Local
Suction Over Temp Lockout	82	4 Hours	System Malfunction
Low Pressure Lockout for 4 hours	83	4 Hours	System Malfunction
High Pressure Lockout for 4 hours	84	4 Hours	System Malfunction
Fan Inverter Current Lockout	86	6	System Malfunction
Compressor/Inverter Lockout	88	2 Hours	System Malfunction
Inverter VDC-Out Over Voltage Event	91	6	Local
Inverter VDC-Out Under Voltage Event	92	6	Local
Compressor Over Current Lockout	95	2 Hours	System Malfunction
VDC Under Voltage Lockout	96	2 Hours	System Malfunction
VDC Over Voltage Lockout	97	2 Hours	System Malfunction
High Torque Event	98	N/A	Event
High Torque Lockout	99	2 Hours	System Malfunction
--	OFF	N/A	No Power

* Short Flashes indicate the first digit in the status code followed by long flashes indicating the second digit of the status code.

** Local Faults displayed only on amber LED and not on generic wall control or recorded in fault history.



342865-101 REV. A

Fig. 39 – Fault Code Label

Table 6—Fault Code Actions

Flash Code	Type	Amber LED Description	Reset Time	Mode	Possible Causes	Actions
ON, no flash		Standby				
1, pause		Variable Capacity			Normal Operation for communicating system	
1 (2 sec ON), longer pause (1 second OFF)		Variable Capacity (Range Cutback)			Speed Limiting for communicating systems	
1, pause		2–stage "Low" Capacity			Low capacity for non–communicating	
2, pause		2–stage "High" Capacity			High capacity for non–communicating	
4, pause		2–stage "Reduced" Capacity			Speed Limiting for non–communicating systems	
25	System Malfunction	INVALID MODEL PLUG/INVERTER SIZE	NA	Both	Missing model plug	Install the correct model plug
					Wrong Model Plug Installed	Verify correct model plug installed
					Damaged Model Plug	Check model plug for corrosion or breakage; replace if necessary. Check Model Plug resistance per the wiring diagram
					Model Plug not fully engaged on board	Align per the silkscreen layout
					Incorrect Model Plug with Inverter Size	Replace plug or inverter with correct size (If model plug is for 2 Ton but Inverter is 3 Ton, fault code 25 will be shown)
					Damaged AOC control	Replace AOC control
31	Fault	HIGH PRESSURE SWITCH OPEN (Stage down for each occurrence, elevates to fault code 84 when it occurs while running on the lowest stage. Reduced capacity is cleared when system has been continuously running at any stage for 2 hours with reduced capacity.)	6 Minutes (then reduced stage operation)	Both	Refer to fault code 84	
32	Local	LOW PRESSURE TRIP (Elevates to fault code 83 after 3 occurrences)	6 Minutes	Both	Refer to fault code 83	
33	Local	LOST INVERTER COMMUNICATIONS (Occurs after 2 minutes of no communications between AOC and MOC) (Elevates to fault code 48 after 3 consecutive failures within 20 minute or 20 minutes continuous loss of connection)	NA	Both	Refer to fault code 48	
46	Local	BROWNOUT EVENT	6 Minutes	Both	Low line voltages	Check for line voltage approximately greater than 180V. If voltage less than 180V and if persistent contact power provider
					Bad connection on L1 and L2	Check for connection on line and load side to verify connection is good.
					Inverter not reading proper voltage	Verify no action issue from the above list then replace inverter.
48	System Malfunction	LOST INVERTER COMMUNICATIONS (Elevated from fault code 33 after 3 occurrences)	NA	Both	Loose or disconnected harness (Hardness between AOC (PL20) and MOC)	Verify good harness connection
					Radio or Electrical noise	System will try to self–mitigate with repeated start attempts
					Possible damage to inverter	change out the Inverter drive
49	Local	COMPRESSOR OVER CURRENT FAULT (Elevates to fault code 95 after 5 occurrences)	6 Minutes	Both	Refer to fault code 95	

Flash Code	Type	Amber LED Description	Reset Time	Mode	Possible Causes	Actions
53	Fault	OUTDOOR AIR TEMP SENSOR FAULT	NA	Both	Sensor Harness not connected to AOC control	Ensure plug is connected to AOC control
					Broken or loose harness wire	Check harness for continuity; see resistance chart to check resistance at given temperature
					Broken or Damaged Sensor	Check harness for continuity; see resistance chart to check resistance at given temperature
					Hardware damage to AOC control	Replace AOC control
54	Fault	SUCTION TEMP SENSOR FAULT	NA	Both	Sensor Harness not connected to AOC control	Ensure plug is connected to AOC control
					Broken or loose harness wire	Check harness for continuity; see resistance chart to check resistance at given temperature
					Suction Thermistor not properly attached or in wrong location	Ensure Sensor is properly attached to the accumulator entry –tube
					Broken or Damaged Sensor	Check harness for continuity; see resistance chart to check resistance at given temperature
					Hardware damage to AOC control	Replace AOC control
55	Fault	COIL TEMP SENSOR FAULT	NA	Both	Sensor Harness not connected to AOC control	Ensure plug is connected to AOC control
					Broken or loose harness wire	Check harness for continuity; see resistance chart to check resistance at given temperature
					Coil Thermistor not properly attached or in wrong location	Ensure Sensor is properly clipped to the distributor entry –tube
					Broken or Damaged Sensor	Check harness for continuity; see resistance chart to check resistance at given temperature
					Hardware damage to AOC control	Replace AOC control
56	Event	OAT –OCT THERMISTOR OUT OF RANGE	NA	Cool	Heating when cooling is demanded	Check fuse on AOC control
						Check wiring between AOC and reversing valve
						troubleshoot reversing valve
						Inspect outdoor coil for obstructions
				Both	Coil Thermistor not properly attached or in wrong location	Ensure Sensor is properly clipped to the distributor entry –tube
					Outdoor Ambient Temperature sensor improperly installed (sensor body may be in contact with sheet metal)	Properly install OAT sensor
57	Fault	SUCTION PRESSURE SENSOR FAULT	NA	Both	Sensor Harness not connected to AOC control	Ensure plug is connected to AOC control
					Broken or loose harness wire	Check harness
					Electrical short destroyed Transducer electronics	Compare transducer reading to gauge reading at service valve (see transducer measurement chart); Check system for electrical shorts and correct; replace transducer
					Heat damage during brazing	Compare transducer reading to gauge reading at service valve (see transducer measurement chart); replace transducer

Flash Code	Type	Amber LED Description	Reset Time	Mode	Possible Causes	Actions
59	Local	DISCHARGE TEMP OUT OF RANGE EVENT (Stage down for each occurrence, elevates to fault code 74 after 5 occurrence. Reduced capacity is cleared if demand cycle is satisfied without ODT reaching limit, or system has been continuously running at any stage for 2 hours with reduced capacity)	15 Minutes	Both	Refer to fault code 74	
61	Local	FAN INVERTER FAULT (elevates to fault code 76 after 5 occurrences)	6 Minutes	Both	Fan motor failed to start	Troubleshoot outdoor fan motor & blade and make sure they are working
					Fan motor rotor misalignment	System will attempt to run again
					Refer to fault code 76	
63	Local	FAN INVERTER CURRENT FAULT (elevates to fault code 86 after 5 occurrences)	6 Minutes	Both	Refer to fault code 86	
65	Local	DC VOLTS LOW – SPEED LIMITING	NA	Both	Caused by other fault code shut down	System will attempt to run again
					Low supply line voltage (< 197 VAC)	Check supply voltage to ODU; if low contact utility provider
					Loose wire in control box area	Loose wire: check for loose wire in ODU
					Inverter internal damage	Replace Inverter
66	Event	OUTDOOR FAN DROPPED OUT	6 Minutes	Both	MOC is reporting that fan motor isn't running	Troubleshoot fan motor and make sure it is working
					3T Inverter enters test mode	Replace inverter with latest software
67	Event	STATOR HEATER FAULT	6 Minutes	Both	There is a demand for stator heat but MOC doesn't detect it	Check compressor winding resistance or miswire of compressor leads at terminals U,V,W
					Damaged inverter generating other inoperable fault codes such as 88, 95	Replace Inverter
68	Event	10 MIN STAGE 2 WARMUP DELAY	10 Minutes	Both	High voltage power cycle	No action
69	System Malfunction	INVERTER/COMPRESSOR INTERNAL FAULT (Elevates to this fault code after 5 hidden occurrences of itself)	15 Minutes	Cool	Overcharged System	Check system subcooling to determine charge status, if high remove charge using Charging Mode (follow proper charging procedures)
				Heat	Overcharged System	Check charge in heating mode per heating check charge chart. If pressures do not match then pull out charge, weigh in using heating charge method
				Both	Phase imbalance/compressor or inverter miswire	Check compressor winding resistance or miswire of compressor leads at terminals U,V,W
					Flooded start	Troubleshoot EXV & TXV
					Inverter damage	Replace inverter
				Compressor damage	Replace compressor	
71	Event	COMPRESSOR DROPPED OUT	6 Minutes	Both	MOC is reporting that compressor isn't running	Refer to TIC 2015–0017 for more details
					3T Inverter enters test mode	Replace inverter with latest software
72	Local	SUCTION OVER TEMPERATURE EVENT (elevates to fault code 82 after 3 occurrences)	15 Minutes	Both	Refer to fault code 82	

Flash Code	Type	Amber LED Description	Reset Time	Mode	Possible Causes	Actions
74	System Malfunction	DISCHARGE TEMP OUT OF RANGE LOCKOUT (Elevated from fault code 59 after 5 occurrences)	2 Hours	Cool	High Load conditions	Over charge: Check system charge
				Heat	Low Charge or Loss of Charge at low ambient heating conditions	Check charge in heating mode per heating check charge chart. If pressures do not match then pull out charge, weigh in using heating charge method
				Heat	Expansion Device Restriction	Heating: Trouble shoot EXV (coil, harnesses); Trouble shoot the TXV Power Cycle system, is EXV moving on power up (audible)
				Both	Sensor Harness not connected to AOC control	Ensure plug is connected to AOC control
					Broken or loose harness wire	Check harness for continuity; see resistance chart to check resistance at given temperature
					Broken or Damaged Sensor	Check harness for continuity; see resistance chart to check resistance at given temperature
					Indoor Unit Airflow too low or off	Troubleshoot indoor fan motor and make sure it is working
					Outdoor Unit Airflow too low or off	Troubleshoot outdoor fan motor and make sure it is working
					Reversing Valve Bypass or Reversing Valve not energized	Reversing Valve stuck halfway Ensure AOC fuse is good 24 VDC in cooling mode Check harness and connectors
				Both	Hardware damage to AOC control	Replace AOC control
Both	Nuisance fault during non-operational mode	Refer to TIC 2015-0017 for more details				
75	Local	MAXIMUM POWER MODE – TEMP (Temporary RPM reduction or stage lowering will result)	NA	Heat	Indoor Airflow too low or off	Check indoor airflow
				Both	Outdoor Airflow too low or off	Check ODU coil for clogging (ice or debris) and clean if necessary; Troubleshoot ODU fan motor and make sure it is working
					Blocked Inverter Heat Exchanger (fins)	Check Inverter fins for debris and clean if necessary
					Application violates guideline	Consult Application Guideline for compliance
76	System Malfunction	FAN INVERTER LOCKOUT (Elevated from fault code 61 after 5 occurrences)	2 Hours	Both	Fan blade bent/out of balance	Check outdoor fan blade Check for ice build up
					Fan blade restricted	Check outdoor fan blade clearance Check for ice build up
					Fan motor wiring	Check outdoor fan motor connectors and harness
					Fan motor	Replace outdoor fan motor
					Inverter damage	Replace inverter
77	Local	MAXIMUM POWER MODE – COMP CURRENT (Temporary RPM reduction or stage lowering will result)	NA	Cool	Overcharged System	Check system subcooling to determine charge status, if high remove charge using Charging Mode (follow proper charging procedures)
				Heat	Overcharged System	Check charge in heating mode per heating check charge chart. If pressures do not match then pull out charge, weigh in using heating charge method
				Both	Compressor is operating outside the allowed operational envelope	Inverter will reduce speed to a lower stage
					Incorrect refrigerant charge	Check refrigerant amount
					Outdoor Airflow too low or off	Check ODU coil for clogging (ice or debris) and clean if necessary; Troubleshoot ODU fan motor and make sure it is working
					Incoming power supply voltage	Check voltage versus unit rating plate for allowable range
					Loose or incorrect wire connections	Check incoming power leads and leads to the compressor plug

Flash Code	Type	Amber LED Description	Reset Time	Mode	Possible Causes	Actions
79	Local	COMPRESSOR/INVERTER FAULT (Elevates to fault code 88 after 5 occurrences)	6 Minutes	Both	Compressor fails to start	System will try to self-mitigate with repeated start attempts
					Refer to fault code 88	
82	System Malfunction	SUCTION OVER TEMP LOCKOUT (Elevated from fault code 72 after 3 occurrences)	4 Hours	Cool	Undercharged System	Check system subcooling to determine charge status, if low add charge using Charging Mode (follow proper charging procedures)
				Cool	Uninsulated vapor line	Insulate the vapor line
				Cool	Indoor TXV operation	Troubleshoot TXV
				Heat	Undercharged System	Check charge in heating mode per heating check charge chart. If pressures do not match then pull out charge, weigh in using heating charge method
				Heat	Outdoor EXV operation	Troubleshoot EXV
				Both	Reversing valve bypass	Troubleshoot reversing valve
83	System Malfunction	LOW PRESSURE LOCKOUT FOR 4 HOURS (Elevated from fault code 32 after 3 occurrences)	4 Hours	Cool	Service Valve left closed (Liquid or Vapor)	Ensure Service Valves are open
				Cool	Undercharged System	Check system subcooling to determine charge status, if low add charge using Charging Mode (follow proper charging procedures)
				Cool	Indoor Airflow too low or off	Check Indoor for clogging (ice or debris) and clean or de-ice if necessary; Troubleshoot Indoor fan motor and make sure it is working; follow Indoor Airflow troubleshooting instruction
				Cool	Restriction in Circuits or Tubing	Repair restriction
				Heat	EXV Malfunction	Troubleshoot EXV (see guide below)
				Heat	Service Valve left closed (Liquid Service Valve)	Ensure Liquid Service Valve is open
				Heat	Outdoor Airflow too low or off	Check Outdoor for clogging (ice or debris) and clean or de-ice if necessary; Troubleshoot Outdoor fan motor and make sure it is working; follow Outdoor Airflow troubleshooting instruction
				Heat	Undercharged System	Check charge in heating mode per heating check charge chart. If pressures do not match then pull out charge, weigh in using heating charge method
				Both	Restriction in Filter Drier	Check for temperature drop across filter drier and replace if necessary
				Both	Expansion Device Restriction	If short lineset (less than 15 ft.) Troubleshoot TXV (see guide below); replace if necessary

Flash Code	Type	Amber LED Description	Reset Time	Mode	Possible Causes	Actions
84	System Malfunction	HIGH PRESSURE LOCK-OUT FOR 4 HOURS (Elevated from fault code 31 when the stage (speed) can no longer be lowered)	4 Hours	Cool	Outdoor Airflow too low or off	Check Outdoor Coil for clogging (ice or debris) and clean or de-ice if necessary; Troubleshoot Outdoor fan motor and make sure it is working; follow Outdoor Airflow troubleshooting instruction
				Cool	Overcharged System	Check system charge using Cooling Charging Mode (follow proper charging procedures)
				Cool	TXV malfunction (In-door) causing an overcharged condition	
				Cool	Restriction in EXV assembly plus Long Line Application leading to Overcharge when charging in Cooling mode	Troubleshoot EXV
				Cool	Restriction in Circuits or Tubing	Repair restriction
				Heat	Indoor Airflow too low or off	Troubleshoot indoor fan motor and make sure it is operating; follow indoor airflow troubleshooting instruction. Check Indoor coil or filter for restriction (debris) and clean if necessary;
				Heat	Furnace plus Heat pump application: Furnace stuck on	If not in Defrost and Furnace is running same time as heat pump, troubleshoot Furnace
				Heat	Overcharged System	Remove refrigerant, evacuate and recharge system using weigh in method. Return to check charge to subcooling when conditions are favorable in cooling mode
				Heat	Reversing Valve Stuck in Cooling	troubleshoot reversing valve
				Both	Service Valve left closed (Liquid or Vapor)	Ensure Service Valves are open
				Both	Loose High Pressure Switch harness leads	Check HPS harness, pins and connectors
				Both	Pressure Switch disconnected from the inverter	Check HPS connection to the inverter
				Both	Restriction of filter drier	Check for temperature drop across filter drier and replace if necessary
				Both	Non-condensable leading to high pressure situation	Remove refrigerant, replace filter drier, evacuate and recharge system
				Both	Faulty Pressure Switch	Check Discharge pressure with gauge, if less than 600 +/- 20 psig and switch is open (measure resistance) then replace pressure switch
				86	System Malfunction	FAN INVERTER CURRENT LOCKOUT (Elevated from fault code 63 after 5 occurrences)
Restriction on fan rotation / motor	Troubleshoot outdoor fan motor & blade and make sure they are working.					
Intermittent harness plug connection	Check harness and connectors. Make sure there is a positive lock between the harness and the board					
Fan blade bent/out of balance	Replace fan blade					
Inverter damage	Replace inverter					

Flash Code	Type	Amber LED Description	Reset Time	Mode	Possible Causes	Actions
88	System Malfunction	COMPRESSOR / INVERTER LOCKOUT (Elevated from fault code 79 after 5 occurrences)	2 Hours	Both	Blocked Inverter Heat Exchanger (fins)	Check Inverter fins for debris and clean if necessary
					Condenser Airflow too low or off	Check Condenser (IDU in heating, ODU in cooling) for clogging (ice or debris) and clean if necessary; Troubleshoot fan motor and make sure it is working
					Evaporator Airflow too low or off	Check Evaporator (IDU in cooling, ODU in heating) for clogging (ice or debris) and clean if necessary; Troubleshoot fan motor and make sure it is working
					High Load conditions at cold ambient heating or high ambient cooling	Over charge: Check system charge
					Inverter damage	Replace inverter
91	Local	INVERTER VDC – OUT OVER VOLTAGE EVENT (Elevates to fault code 97 after 5 occurrences)	5 Minutes	Both	Compressor is suddenly unloaded	Check that the service valves are fully open
					Refer to fault code 97	
92	Local	INVERTER VDC – OUT UNDER VOLTAGE EVENT (Elevates to fault code 96 after 5 occurrences)	5 Minutes	Both	Refer to fault code 96	
95	System Malfunction	COMPRESSOR OVER CURRENT LOCKOUT (Elevated from fault code 49 after 5 occurrences)	2 Hours	Cool	Outdoor Airflow too low or off	Check ODU coil for clogging (ice or debris) and clean if necessary; Troubleshoot ODU fan motor and make sure it is working
				Both	High superheat	Troubleshoot TXV
						Troubleshoot EXV
						Check suction pressure transducer and suction temperature sensor
				Both	Compressor is operating outside the allowed operational envelope	Inverter will reduce speed to a lower stage
				Both	Incoming power supply voltage	Check voltage versus unit rating plate for allowable range
					Loose or incorrect wire connections	Check incoming power leads and leads to the compressor plug
					Phase imbalance	Check compressor winding resistance or miswire of compressor leads at terminals U,V,W
				Both	Refrigerant over-charge	Check refrigerant amount
					Inverter damage	Replace inverter
Compressor internal damage	Replace compressor					
96	System Malfunction	VDC UNDER VOLTAGE LOCKOUT (Elevated from fault code 92 after 5 occurrences)	2 Hours	Both	Low supply line voltage (< 197 VAC)	Check supply voltage to ODU; if low contact utility provider
					Inverter internal damage	Replace Inverter
97	System Malfunction	VDC OVER VOLTAGE LOCKOUT (Elevated from fault code 91 after 5 occurrences)	2 Hours	Both	High supply line voltage (> 253 VAC)	Check supply voltage to ODU; if high contact utility provider
					Inverter internal damage	Replace Inverter
98	Event	HIGH TORQUE EVENT (Event will cause stage down and when stage is at lowest level, will elevate to fault code 99)	NA	Both	Compressor is operating outside the allowed operational envelope	Inverter will reduce speed to a lower stage
				Both	Refer to fault code 99	

Flash Code	Type	Amber LED Description	Reset Time	Mode	Possible Causes	Actions
99	System Malfunction	HIGH TORQUE LOCKOUT (Elevated from fault code 98 when 98 occurs at lowest stage)	2 hours	Cool	Overcharged System	Check system subcooling to determine charge status, if high remove charge using Charging Mode (follow proper charging procedures)
				Heat	Overcharged System	Check charge in heating mode per heating check charge chart. If pressures do not match then pull out charge, weigh in using heating charge method
				Both	Miswire	Check miswire of compressor leads at terminals U,V,W
				Both	Outdoor Airflow too low or off	Check ODU coil for clogging (ice or debris) and clean if necessary; Troubleshoot ODU fan motor and make sure it is working
				Both	Expansion Device Restriction	Troubleshoot TXV
						Troubleshoot EXV
Heat	Overcharged System	Check charge in heating mode per heating check charge chart. If pressures do not match then pull out charge, weigh in using heating charge method				

Variable Speed Drive LED Location and Description (Sizes 13 and 24B)

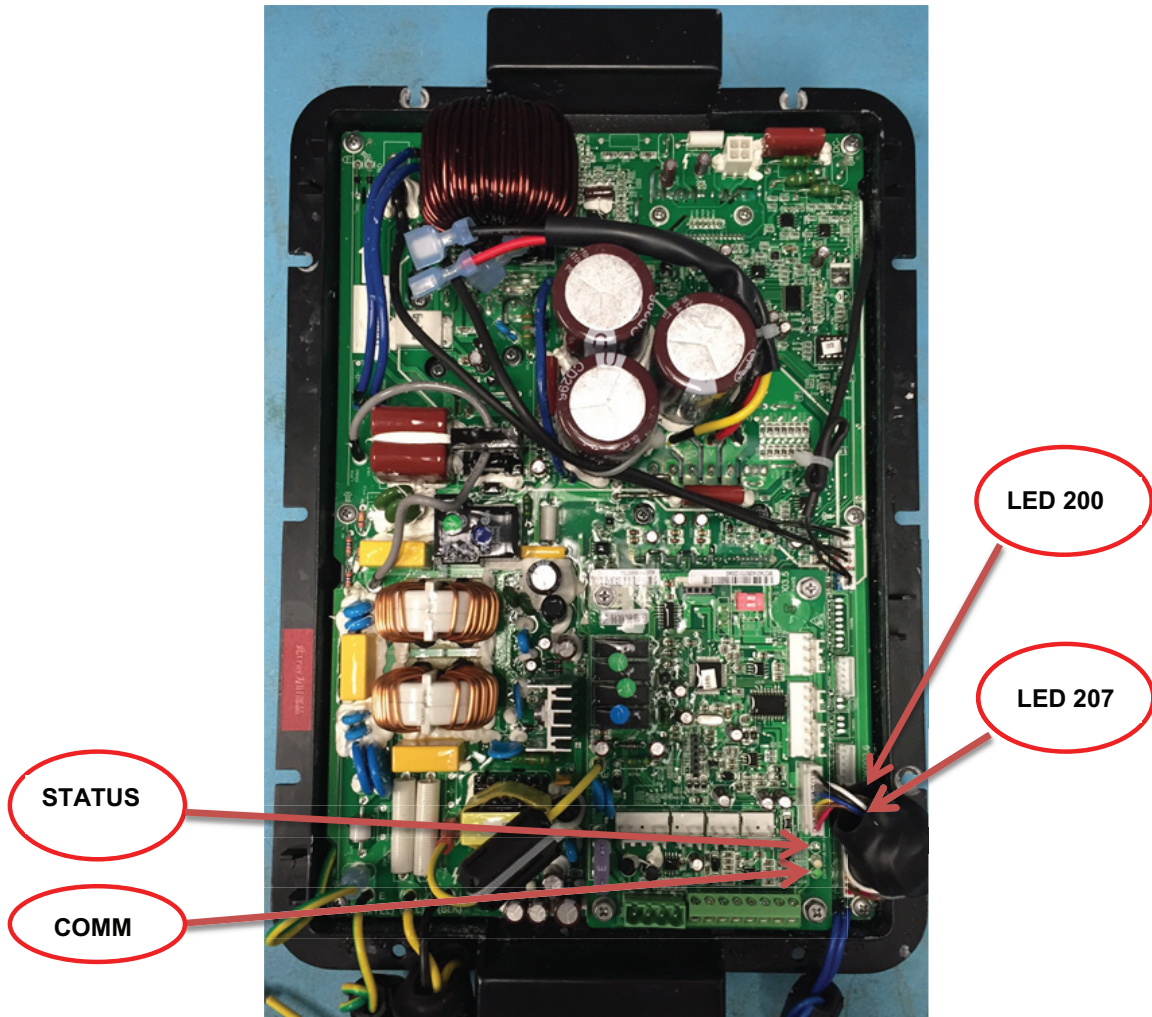

MOC LED Description (Sizes 13 and 24B)

Reference	Color	Status	Condition	Description
LED200	Red	Steady On	Normal	Indicates MOC powered where DC bus at 40volts or higher
		Off	Abnormal	No power, capacitor voltage drained
LED207	Amber	Steady On	Normal	Compressor is running
		Blinking	Abnormal	If compressor stops, it indicates some fault happening; If compressor is running, it indicates speed is limited or reduced.
		Off	Normal	Compressor stops and no fault

AOC LED Descriptions (Sizes 13 and 24B)

Reference	Color	Status	Condition	Description
STATUS	Amber	Steady On	Normal	AOC status –standby mode
		Blinking	Abnormal	AOC function/fault status
COMM	Green	Steady On	Normal	Communication from AOC to indoor wall control

LED Not Functioning Properly – Requires AOC or Inverter Replacement

Reference	Color	Suspect AOC board	Failure Description
STATUS	Amber	If Amber STATUS light is not on (neither steady nor blinking), with power to outdoor unit	AOC STATUS is not functioning properly and AOC board should be replaced.
COMM	Green	In Communicating mode, if Green COMM LED is not on when AB indoor wires are connected to AOC AB connector and indoor has communications	AOC is not capable of communicating with indoor; AOC board should be replaced.

UI Fault Codes requiring AOC or Inverter Replacement

Fault Code Description	Fault Code	Failure Description
Communications Loss	179	Loss of communication with outdoor unit AOC board; AOC or Inverter may need to be replaced

NOTE: If any of the AOC control board header pins are damaged or are not making good contact, AOC board should be replaced.

Variable Speed Drive LED Location and Description (Sizes 25, 36, 37, 48, 49 and 60)

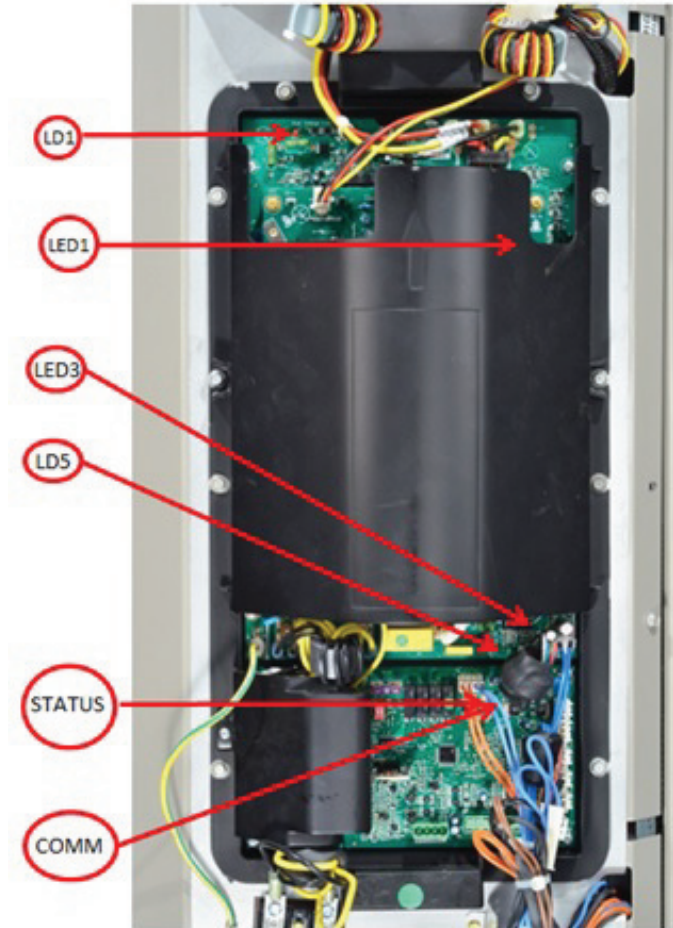

MOC LED Description (Sizes 25, 36, 37, 48, 49 AND 60)

Reference	Color	Status	Description
LD1	Red	Steady On	MOC powered where DC bus is 40volts or greater
		Off	No power, capacitor voltage drained
LED1	Red	Steady On	DCF and board DC high voltage and discharge circuit powered on
		Off	No power
LED3	Amber	Steady On	MOC board switching power supply to power AOC board on
		Off	No Power
		Blinking	Indicates communication from MOC to AOC
LD5	Green	Steady On	Indicates 5 volt connection status OK between AOC and MOC
		Off	No Power

AOC LED Descriptions (Sizes 25, 36, 37, 48, 49 AND 60)

Reference	Color	Status	Description
STATUS	Amber	Steady On	AOC status – standby mode
		Blinking	AOC function/fault status
COMM	Green	Steady On	Communication from AOC to indoor wall control

LED Not Functioning Properly – Requires AOC or Inverter Replacement

Reference	Color	Suspect AOC board	Failure Description
STATUS	Amber	If Amber STATUS light is not on (neither steady nor blinking), with power to outdoor unit	AOC STATUS is not functioning properly and AOC board should be replaced.
COMM	Green	In Communicating mode, if Green COMM LED is not on when AB indoor wires are connected to AOC AB connector and indoor has communications	AOC is not capable of communicating with indoor; AOC board should be replaced.

UI Fault Codes requiring AOC or Inverter Replacement

Fault Code Description	Fault Code	Failure Description
Communications Loss	179	Loss of communication with outdoor unit AOC board; AOC or Inverter may need to be replaced

NOTE: If any of the AOC control board header pins are damaged or are not making good contact, AOC board should be replaced.

COMPRESSOR POWER HARNESS ASSEMBLY REPLACEMENT (Reference RCD Instruction # 99TA516170)

The following is a recommended procedure for compressor power harness replacement. Always refer to the unit product installation, start-up & service instructions for detailed procedures.

⚠ WARNING

ELECTRICAL SHOCK HAZARD

Failure to follow this warning could result in personal injury or death.

Turn off and lock out all power to unit before proceeding.
Discharge all capacitors before proceeding

All wiring and electrical connections shall comply with all local and national electrical codes.

⚠ WARNING

ELECTRICAL SHOCK HAZARD

Failure to follow this warning could result in personal injury or death.

failure to follow this warning could result in personal injury.

Do not operate compressor or provide any electrical power to the compressor unless the terminal box cover is in place and secured.

Measurements of amps and volts during running conditions must be taken at other points in the power supply.

Do not provide any power to the compressor unless suction and discharge service valves are open.

Replacement Procedure

1. Follow all safety warnings and notices.
2. Precautions must be taken when servicing components within the control box of this unit. The technician performing the service must determine that it is safe to work on or near the inverter. The electrical disconnect that provides power to the unit must be turned off, locked and tagged out. This will insure that no damage will occur to the inverter, controls or other equipment and will prevent injury if contact is made with the electrical equipment. Wait a minimum of two minutes before servicing the unit to allow inverter capacitors to discharge. Follow safety instructions located on unit control box cover.
3. Remove the control box cover.
4. Disconnect compressor power harness from inverter.
5. Remove service panel to gain access to unit wiring and compressor compartment.
6. Cut the wire ties securing the compressor power harness to the control box. Remove compressor power harness (from control box). Replace wire tie with supplied wire tie; do not fasten at this time. The second wire tie for the choke on the compressor is supplied with new harness on the replacement compressor (highlighted with the yellow circles below).

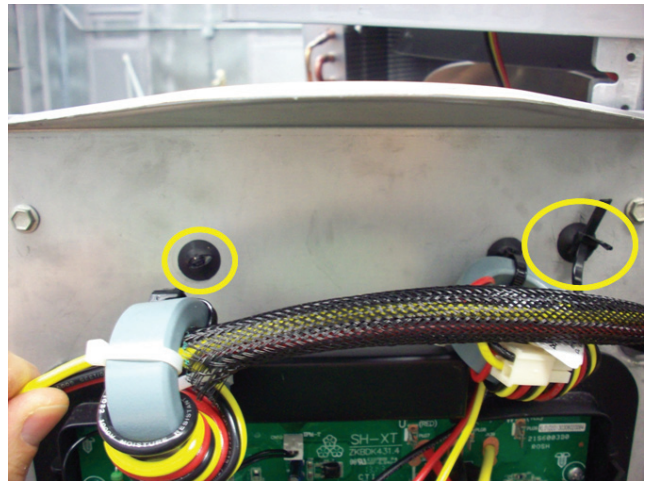

7. Remove top two screws holding control box and remove compressor harness (highlighted in yellow below).

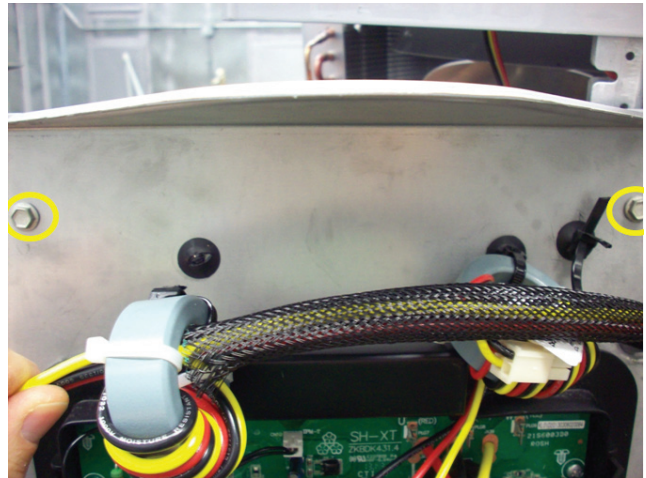

8. Cut double loop wire tie on suction tube holding compressor harness, replace with new one provided; do not fasten at this time. Note how the compressor harness is routed to suction tube. (Highlighted in yellow below)

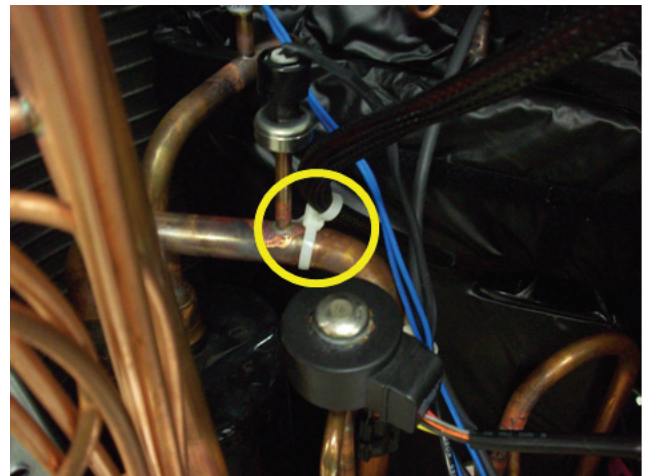

9. With using a slot screwdriver, lift up the on the side tab to pry the cover off from the RTV. Be sure not to break the tab.



10. It may be necessary to leverage the screwdriver against cover next to tab so as not to break the tab while loosening.



11. Once Cover is loosened on one side, use screwdriver along freed edge to remove.



12. Remove cover, unplug old harness, plug in new harness, verify bushing is reinstalled and plug leads leave the terminal box through the bushing; reinstall cover pushing one side down then the other.

NOTE: DO NOT SCRAP SEALANT



13. Reinstall compressor sound blanket making sure discharge thermistor and compressor power harness are routed as they were from the factory.

14. Route compressor power harness to new double loop wire tie and then to the wire retainers in tube sheet (route as they were originally to make sure they will not contact fan blade) and then route into control box and reinstall two control box screws. (See image below)

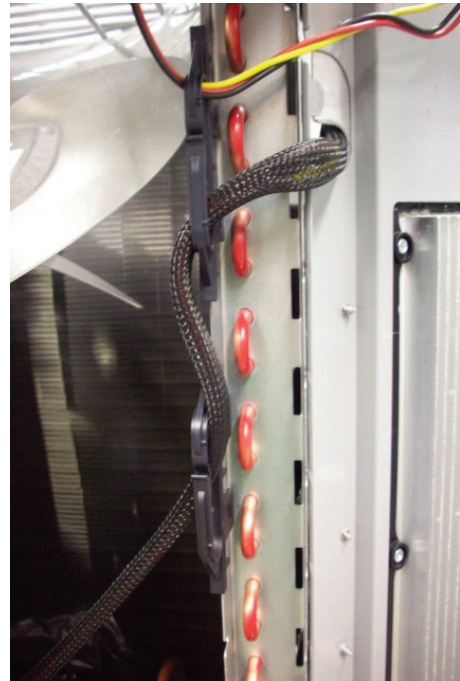

15. Reinstall service panel.
16. Route compressor harness choke to left hand side of the top of control box and push in wire tie. Pull wires tight as they enter control box and tighten second wire tie.
17. Reconnect compressor power harness to the inverter.
NOTE: Reference enclosed wiring diagrams and unit wiring diagrams in Owner's Manual to aid in reattaching electrical connections.
18. Reinstall control box cover.

INVERTER ASSEMBLY w SHIELD GASKET REMOVAL AND INSTALLATION (Reference RCD Instruction # 99TA512018) Also see figures 41 through 42

WARNING

ELECTRICAL SHOCK HAZARD

Failure to follow this warning could result in personal injury or death.

Turn off the electrical supplies to the unit before performing any maintenance or service. Follow the operating instructions on the label attached to the unit

CAUTION

ELECTRICAL OPERATION HAZARD

Failure to follow this caution may result in unit damage or improper operation.

Label all wires prior to disconnection when servicing controls. Wiring errors can cause improper and dangerous operation.

IMPORTANT: DO NOT USE POWER TOOLS TO TIGHTEN THE INVERTER INPUT SCREW TERMINALS

Removing Inverter:

1. Remove power to the unit. Wait a minimum of two minutes before servicing the unit to allow inverter capacitors to discharge. Follow safety instructions located on unit control box cover.
2. Precautions must be taken when servicing components within the control box of this unit. The technician performing the service must determine that it is safe to work on or near the inverter. The electrical disconnect that provides power to the unit must be turned off, locked and tagged out. This will insure that no damage will occur to the inverter, controls or other equipment and will prevent injury if contact is made with the electrical equipment.
3. Remove the control box cover.
4. The inverter capacitors are covered with a protective shield. The shield should not be removed from the inverter.
5. Before servicing the inverter, verify the inverter voltage is zero. Measure the DC voltage at the DC + VOLTAGE and DC - VOLTAGE terminals on the inverter adjacent to the capacitors to ensure that they have totally discharged. The voltage at these terminals must be 0 (zero) before servicing (see following figures).

6. After verifying the voltage has dissipated to zero, disconnect wiring from the inverter.
7. Disconnect three compressor power wires. Note wire color order – Yellow, Red, and Black.
8. Disconnect fan motor power harness plug.
9. Disconnect reversing valve / PEV plug. (See Figure Below)
10. Disconnect high pressure switch plug.
11. Disconnect EXV plug.
12. Disconnect suction pressure transducer plug.
13. Disconnect suction thermistor plug.
14. Disconnect discharge thermistor plug.
15. Disconnect OAT/OCT plug.
16. Disconnect control wiring (ABCD or thermostat connections)
17. Disconnect two input power wires. Note wire color order – Black and Yellow.
18. Disconnect inverter ground lead. Note wire color – Green w/ Yellow Stripe.
19. Remove 12 mounting screws and pull out inverter with cover intact.

Installing New Inverter:

1. Install inverter into control box. Attach (12) mounting screws.
2. Re-connect inverter ground lead. Note wire color – Green w/ Yellow Stripe.
3. Re-connect two input power wires. Note wire color order- Black and Yellow.
4. Re-connect control wiring (ABCD or thermostat connections)
5. Re-connect OAT/OCT plug.
6. Re-connect discharge thermistor plug.
7. Re-connect suction thermistor plug.
8. Re-connect suction pressure transducer plug.
9. Re-connect EXV plug.
10. Re-connect high pressure switch plug.
11. Re-connect reversing valve / PEV plug.
12. Re-connect fan motor power harness plug.
13. Re-connect three compressor power wires. Note wire color order- Yellow, Red and Black.
14. Replace the control box cover.
15. Apply power to the unit.

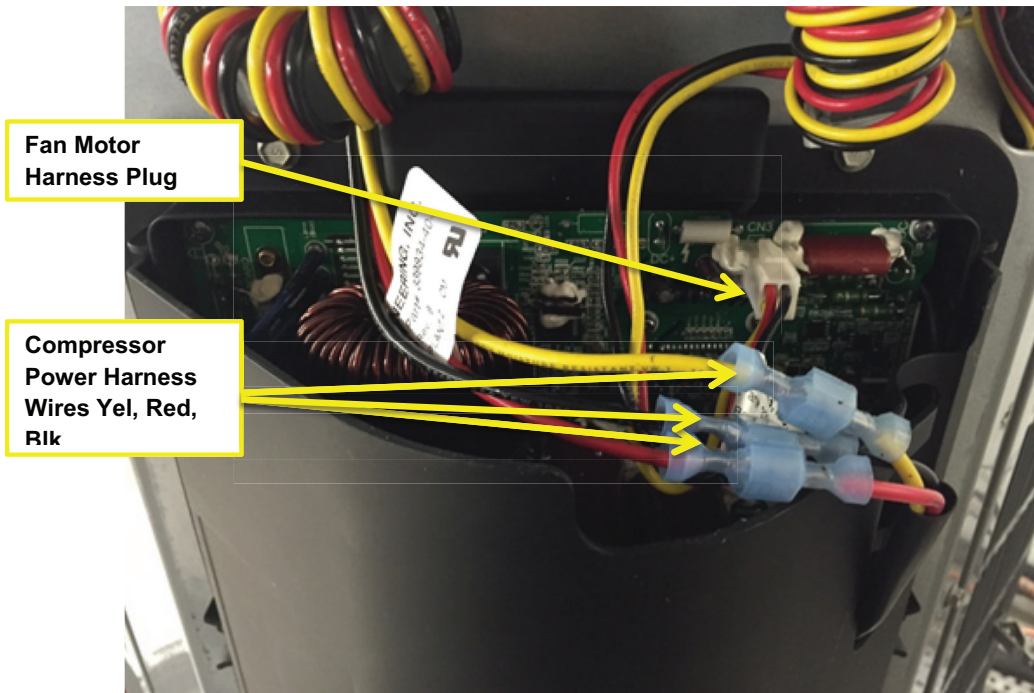

Fan Motor
Harness Plug

Compressor
Power Harness
Wires Yel, Red,
Blk

Fig. 40 – Compressor and Fan Harness
(Unit sizes 13 and 24B)

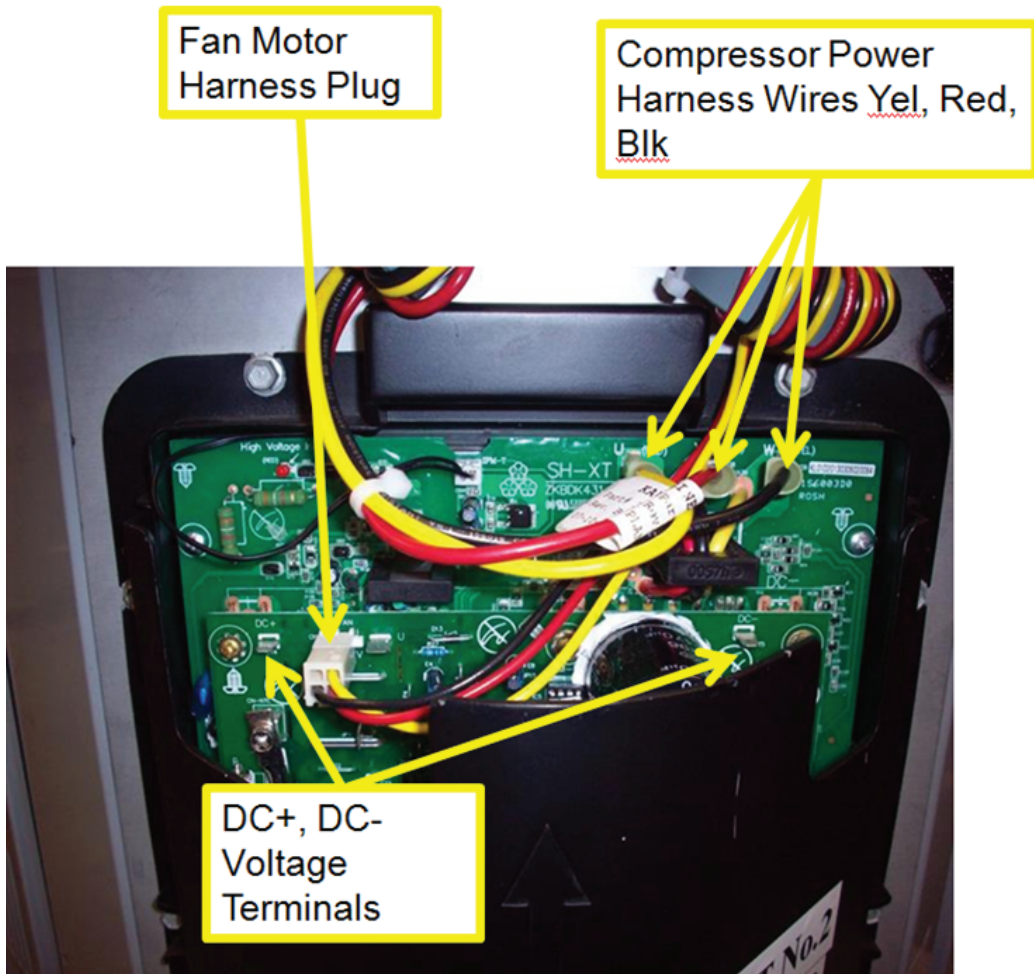

Fan Motor
Harness Plug

Compressor Power
Harness Wires Yel, Red,
Blk

DC+, DC-
Voltage
Terminals

Fig. 41 – Compressor and Fan Harness
(Unit sizes 25, 36, 37, 48, 49 and 60)

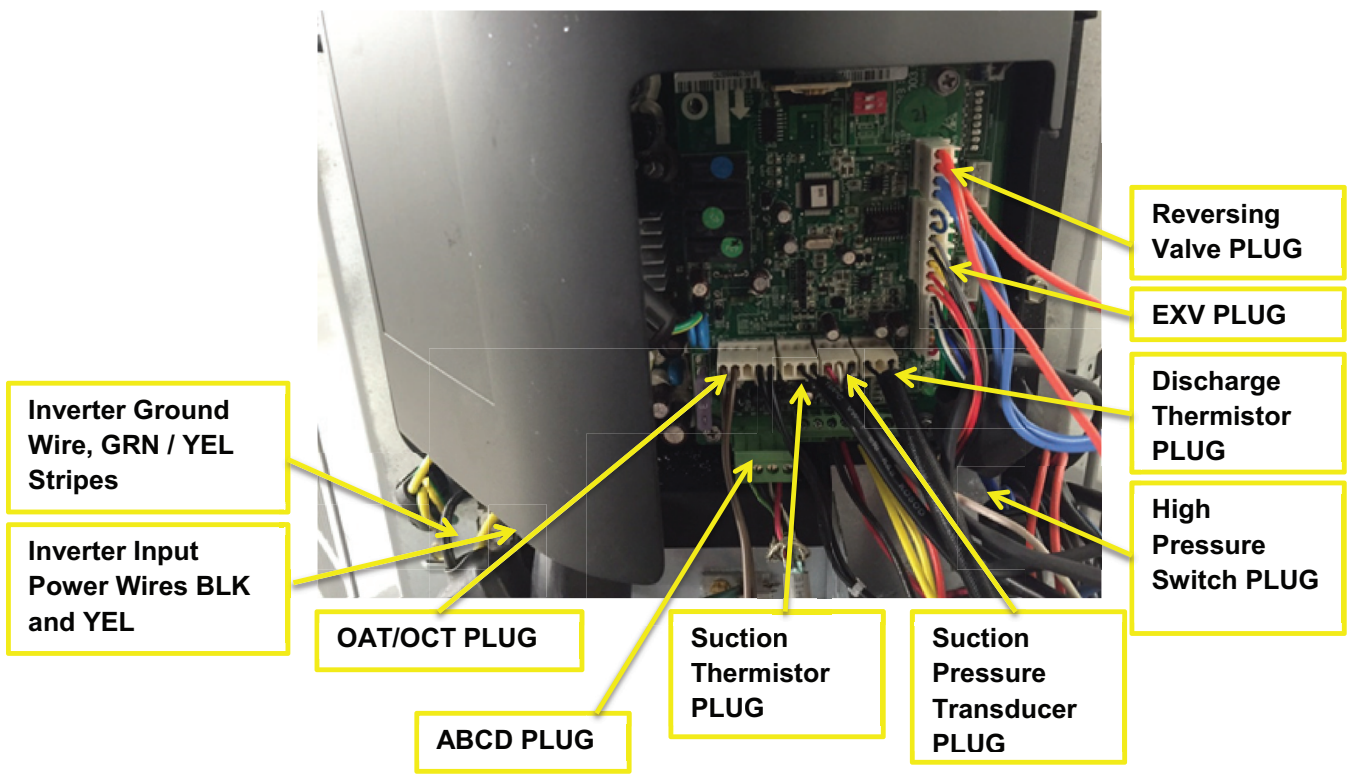

Fig. 42 – Wire Harness Connections
(Unit sizes 13 and 24B)

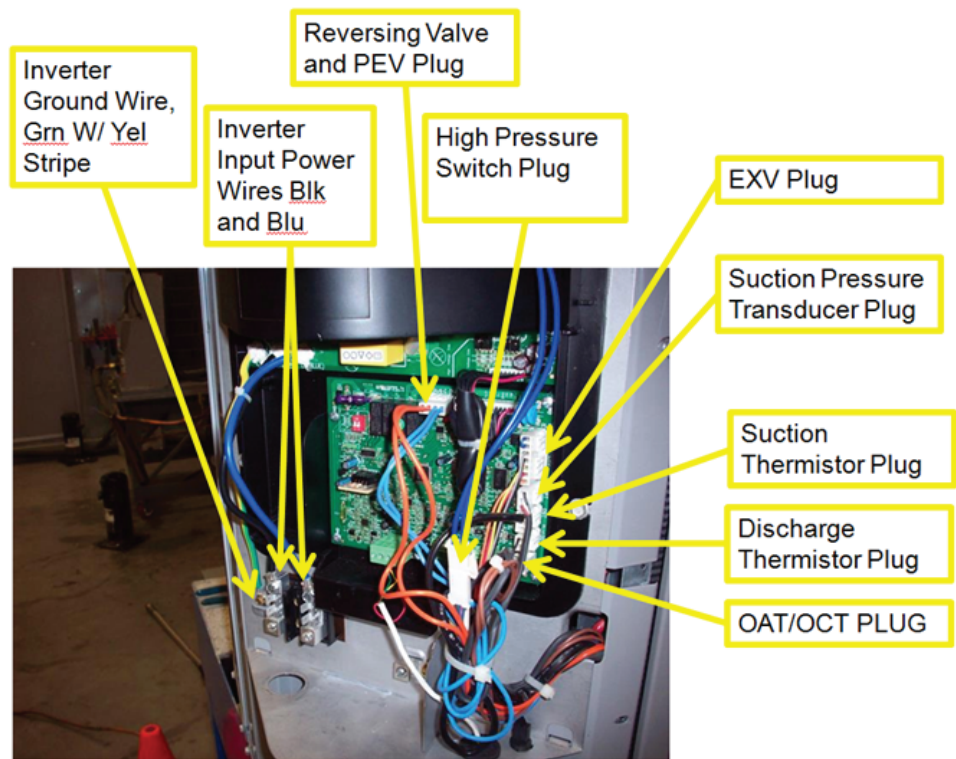

Fig. 43 – Wire Harness Connections
(Unit sizes 25, 36, 37, 48, 49 and 60)

**COMPRESSOR REPLACEMENT
(Reference RCD Instruction # 99TA516169)**

The following is a recommended procedure for compressor replacement. Always refer to the unit product installation, start-up & service instructions for detailed procedures.

⚠ WARNING

ELECTRICAL SHOCK HAZARD

Failure to follow this warning could result in personal injury or death.

Turn off and lock out all power to unit before proceeding. Discharge all capacitors before proceeding

All wiring and electrical connections shall comply with all local and national electrical codes.

⚠ WARNING

PERSONAL INJURY HAZARD

failure to follow this warning could result in personal injury.

Follow recognized safety practices and wear safety glasses, protective clothing, and gloves. Acids formed as a result of motor burnout can cause burns.

⚠ WARNING

PERSONAL INJURY HAZARD

failure to follow this warning could result in personal injury.

do not disassemble bolts, plugs, fittings, etc. until all pressure has been relieved from compressor.

⚠ WARNING

PERSONAL INJURY HAZARD

failure to follow this warning could result in personal injury.

Do not operate compressor or provide any electrical power to the compressor unless the terminal box cover is in place and secured. Measurements of amps and volts during running conditions must be taken at other points in the power supply.

Do not provide any power to the compressor unless suction and discharge service valves are open.

⚠ CAUTION

UNIT DAMAGE HAZARD

failure to follow this caution may result in equipment damage or improper operation.

Only suction line filter driers should be used for refrigerant and oil clean up.

Use of non-approved products could limit system life and void unit warranty.

⚠ CAUTION

UNIT DAMAGE HAZARD

Failure to follow this caution may result in equipment damage or improper operation.

Do not leave system open to atmosphere. compressor oil is highly susceptible to moisture absorption.

At the time of compressor change out and at regular preventative maintenance intervals the acid/moisture content of the system should be checked using an acid/moisture test kit. This can determine, in a few minutes, whether acid and moisture are present in the system. No oil sample is required. Contact your local distributor to purchase this device.

Before Changing the Compressor

Check compressor and associated controls to be sure compressor replacement is necessary.

Failure Classification

The replacement procedure is dependent on the type of failure. The following describes the classification process:

MECHANICAL FAILURES	ELECTRICAL BURNOUT
1. No damage to windings as indicated by electrical check	1. Windings of compressor open or grounded
2. Oil clean and odor free	2. Oil dark with burn odor
3. Symptoms: Excessive Noise Won't Pump Excessively Hot	3. Symptoms Blows fuses or circuit breaker Draws abnormal amount of current

Replacement Procedure for Mechanical Failure

1. Follow all safety warnings and notices.
2. Precautions must be taken when servicing components within the control box of this unit. The technician performing the service must determine that it is safe to work on or near the inverter. The electrical disconnect that provides power to the unit must be turned off, locked and tagged out. This will insure that no damage will occur to the inverter, controls or other equipment and will prevent injury if contact is made with the electrical equipment. Wait a minimum of two minutes before servicing the unit to allow inverter capacitors to discharge. Follow safety instructions located on unit control box cover.
3. Remove and recover all refrigerant from system until pressure gauges read 0 psi. Use all service ports. Never open a system under a vacuum to atmosphere. Break vacuum with dry nitrogen holding charge first. Do not exceed 5 psig.
4. Remove the control box cover.
5. Disconnect compressor power harness from inverter.
6. Remove service panel to gain access to unit wiring and compressor compartment.

7. Cut the wire ties securing the compressor power harness to the control box. Remove compressor power harness (from control box). Replace wire tie with one supplied; do not fasten at this time. The second wire tie for the choke on the compressor is supplied with new harness on the replacement compressor (highlighted with the yellow circles below).

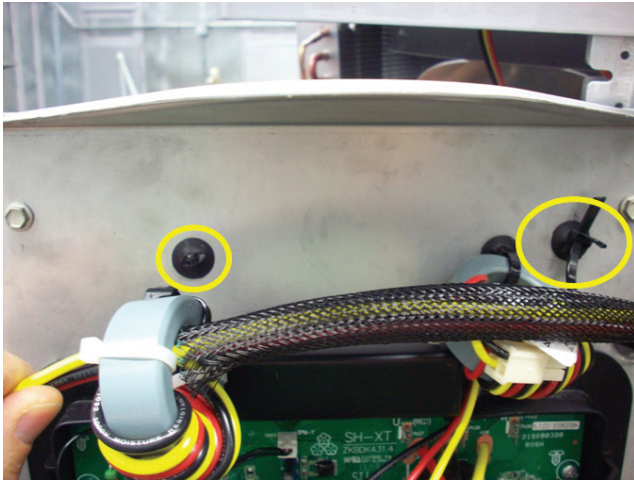

8. Remove top two screws holding control box and remove compressor harness (highlighted in yellow below).

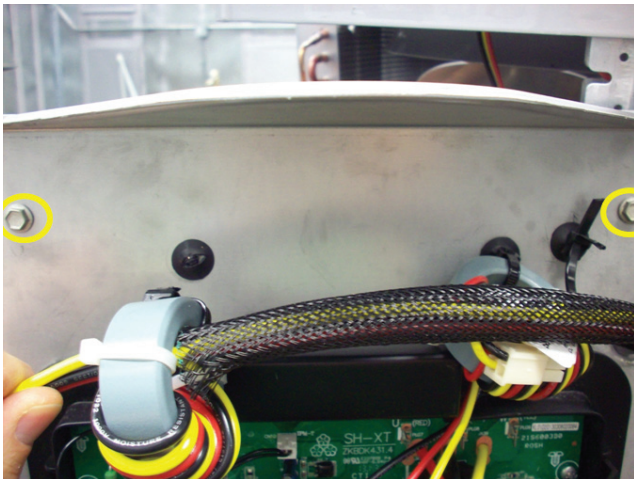

9. Cut double loop wire tie on suction tube holding compressor harness, replace with new one provided; do not fasten at this time. Note how the compressor harness is routed to suction tube (highlighted in yellow below).

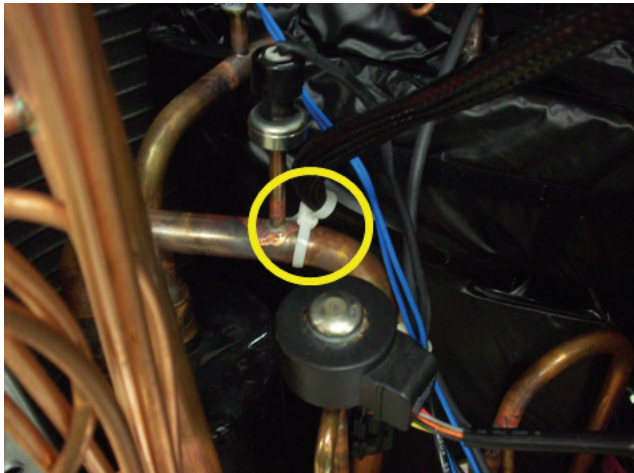

10. Remove compressor mounting hardware.
11. Cut both suction and discharge lines with tubing cutter. Do not use brazing torch for compressor removal as oil vapor may ignite when compressor is disconnected.
12. Using caution and the appropriate lifting devices, remove compressor from the unit.
13. Scratch matching marks on stubs in old compressor. Make corresponding marks on replacement compressor.
14. Use torch to remove stubs from old compressor and install them in replacement compressor.
NOTE: Use appropriate protection to avoid damage to compressor terminal cover and/or terminal box sealant with torch flame. It is intended that terminal cover remain installed during compressor installation.
15. Using caution and the appropriate lifting device, place replacement compressor in unit and secure with appropriate mounting hardware.
NOTE: Use of existing or new OEM mounting hardware is recommended.
NOTE: Compressor grommet and sleeve supplied with the compressor should be evaluated versus OEM hardware before assembling in unit.
16. Use copper couplings to tie compressor back into system.
NOTE: Use appropriate protection to avoid damage to compressor terminal cover and/or terminal box sealant with torch flame. It is intended that terminal cover remain installed during compressor installation.
17. Remove and discard liquid line strainer and filter drier. Replace with filter drier one size larger in capacity than the unit being worked on (use bi-flow) type on heat pump. See *Recommended Filter/Drier Sizes* table below for appropriate size.
18. Reinstall compressor sound blanket making sure discharge thermistor and compressor power harness are routed as they were from the factory.
19. Route compressor power harness to new double loop wire tie and then to the wire retainers in tube sheet (route as they were originally to make sure they will not contact fan blade) and then route into control box and reinstall two control box screws. (See image below)



20. Reinstall service panel.
21. Route compressor harness choke to left hand side of the top of control box and push in wire tie. Pull wires tight as they enter control box and tighten second wire tie.
22. Reconnect compressor power harness to the inverter.
NOTE: Reference enclosed wiring diagrams and unit wiring diagrams in Owner's Manual to aid in reattaching electrical connections.
23. Triple evacuate the system below 1,000 microns.
24. Recharge unit, compensating for larger liquid line filter. Charge compensation for oversize filter drier is listed in the *Recommended Filter/Drier Sizes* table below.
25. Check system for normal operation. If unit is a heat pump, switch from heating to cooling a few times to verify component operation.

Replacement Procedure for Electrical Burnout (System Clean-up)

Mild Burnout

Perform steps 1 – 25 as specified in the Replacement Procedure for Mechanical Failure and then perform steps as follows:

26. Run unit a minimum of 2 hours and replace liquid line filter drier.
27. Use a test kit to determine whether acceptable acid and moisture levels have been attained. If system is still contaminated, repeat step 17. Continue this process until the test kit indicates “clean” system.
28. Check system for normal operation. If unit is a heat pump, switch from heating to cooling a few times to verify component operation.

Severe Burnout

Perform steps 1 – 22 as specified in the Replacement Procedure for Mechanical Failure and then perform steps as follows:

23. Clean or replace TXV.
24. Drain any trapped oil from the accumulator if used.
25. Add suction line filter drier for appropriate unit size as indicated in *Recommended Filter/Drier Sizes* table below. Mount vertical with pressure taps on both inlet and outlet.
NOTE: On heat pumps, install suction line drier between compressor and accumulator.
26. Triple evacuate the system below 1,000 microns.
27. Recharge unit, compensating for larger liquid line filter. Charge compensation for oversize filter drier is listed in *Recommended Filter/Drier Sizes* table below.
28. Run 1 hour minimum and change liquid line drier and suction filter.
29. Run a minimum of 2 or more hours and change liquid filter drier again. Remove suction line filter from system (do not replace suction line filter).
30. Use a test kit to determine whether acceptable acid and moisture levels have been attained. If system is still contaminated, repeat Step 22. Continue this process until the test kit indicates “clean” system.
31. Check system for normal operation. If unit is a heat pump, switch from heating to cooling a few times to verify component operation.

Recommended Filter/Drier Sizes			
Unit Capacity	Quantity	Minimum Required Effective Desiccant Volume	
		Liquid CU. IN.	Suction CU. IN.
1, 2, 3, 4, and 5	1	6.5	15

WIRING DIAGRAMS - 24VNA9

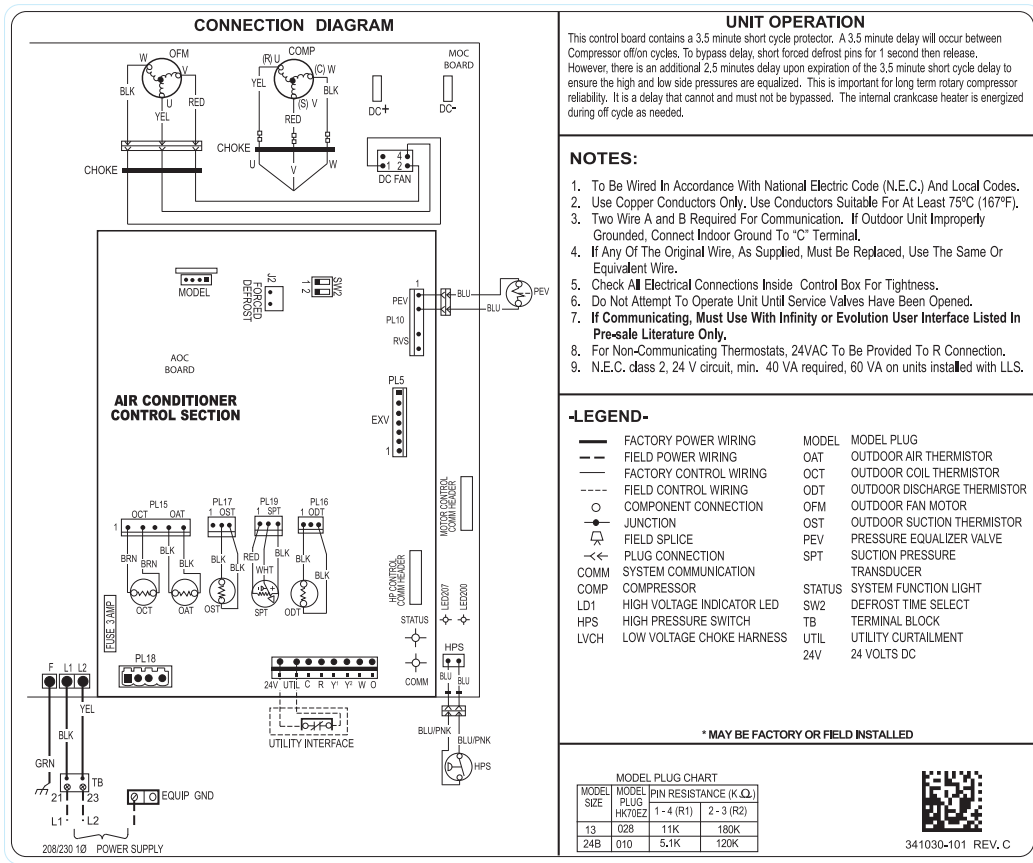

Fig. 44 – 24VNA9 WIRING DIAGRAM - Sizes 13 and 24B

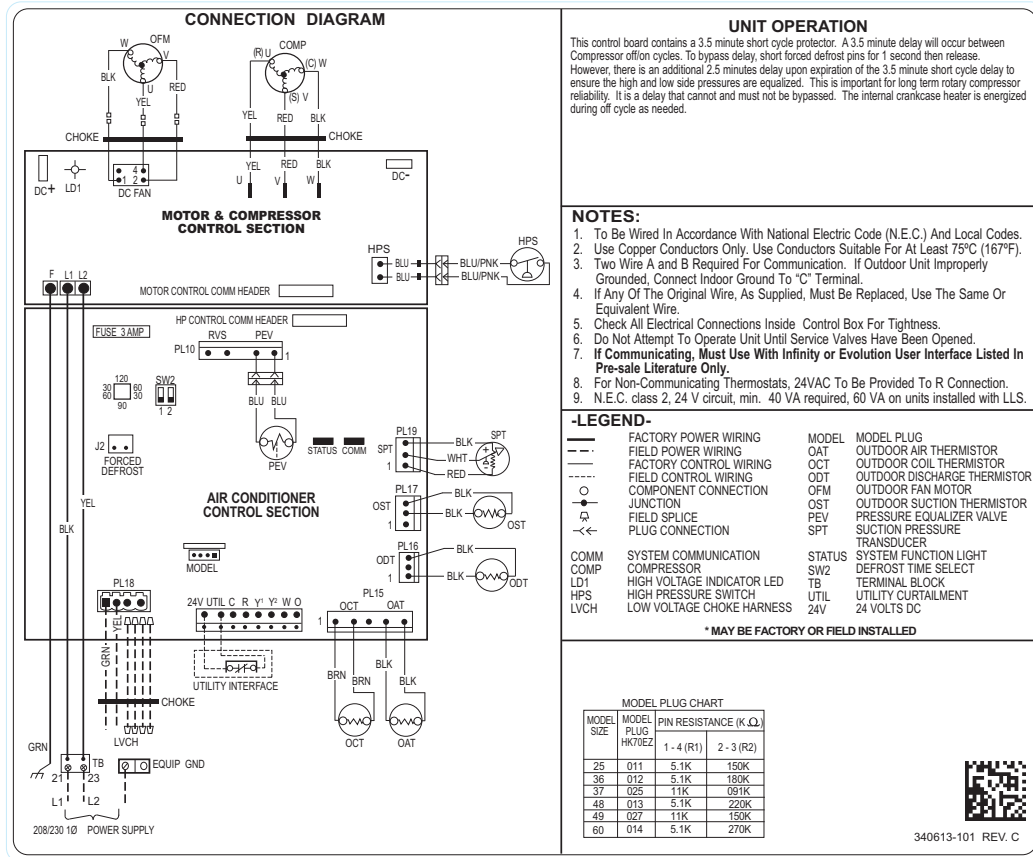

Fig. 45 – 24VNA9 WIRING DIAGRAM - Sizes 25, 36, 37, 48, 49, 60

WIRING DIAGRAMS - 25VNA8

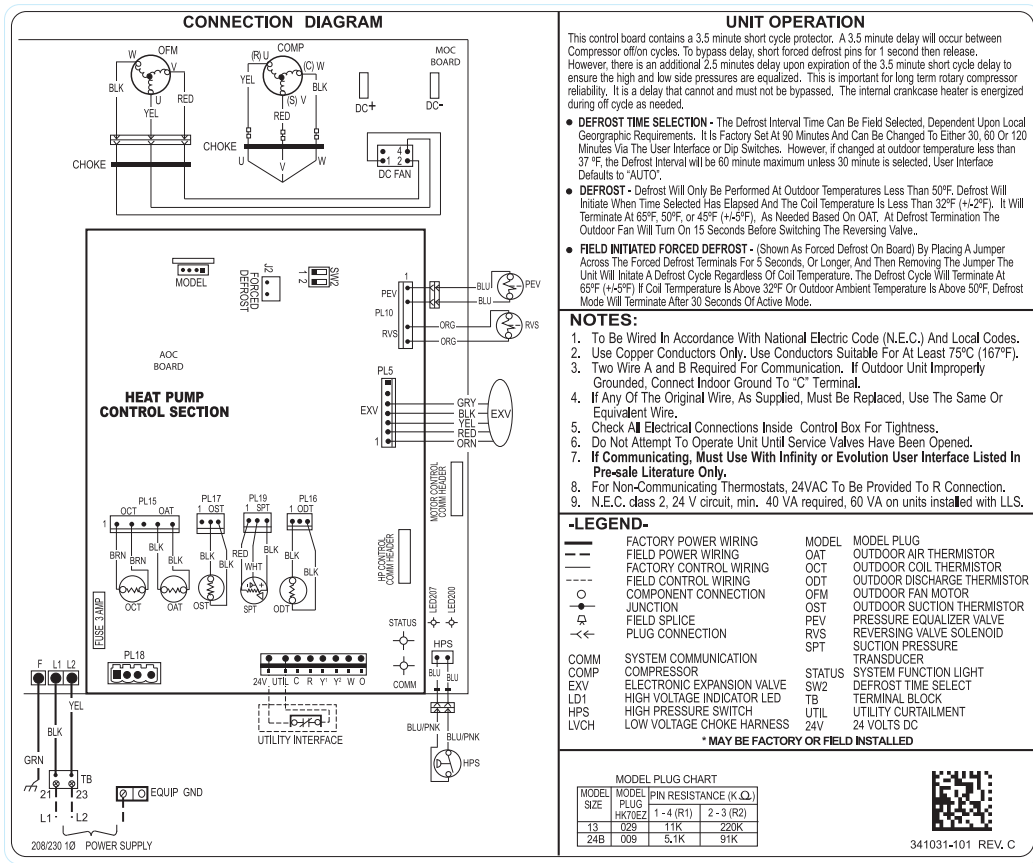

Fig. 46 – 25VNA8 WIRING DIAGRAM - Sizes 13 and 24B

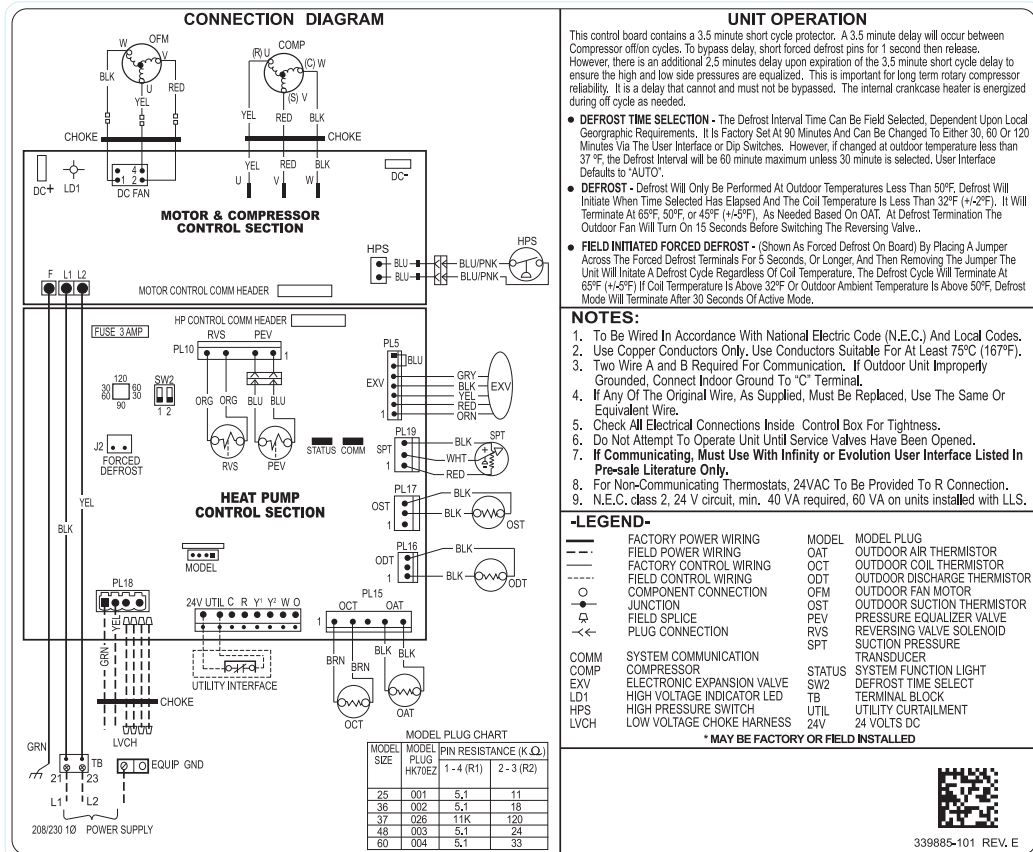

Fig. 47 – 25VNA8 WIRING DIAGRAM - Sizes 25, 36, 37, 48, and 60

REFRIGERATION SYSTEM

Refrigerant

WARNING

UNIT OPERATION AND SAFETY HAZARD

Failure to follow this warning could result in personal injury or equipment damage.

Puron® refrigerant which has higher pressures than R-22 and other refrigerants. No other refrigerant may be used in this system. Gauge set, hoses, and recovery system must be designed to handle Puron®. If you are unsure consult the equipment manufacturer.

In an air conditioning and heat pump system, refrigerant transfers heat from one place to another. The condenser is the outdoor coil in the cooling mode and the evaporator is the indoor coil.

In a heat pump, the condenser is the indoor coil in the heating mode and the evaporator is the outdoor coil.

In the typical air conditioning mode, compressed hot gas leaves the compressor and enters the condensing coil. As gas passes through the condenser coil, it rejects heat and condenses into liquid. The liquid leaves condensing unit through liquid line and enters metering device at evaporator coil. As it passes through metering device, it becomes a gas-liquid mixture. As it passes through indoor coil, it absorbs heat and the refrigerant moves to the compressor and is again compressed to hot gas, and cycle repeats.

Compressor Oil

CAUTION

UNIT DAMAGE HAZARD

Failure to follow this caution may result in equipment damage or improper operation.

The compressor in a Puron® system uses a Polyol Ester (POE) oil. This oil is extremely hygroscopic, meaning it absorbs water readily. POE oils can absorb 15 times as much water as other oils designed for HCFC and CFC refrigerants. Take all necessary precautions to avoid exposure of the oil to the atmosphere.

Servicing Systems on Roofs With Synthetic Materials

POE (Polyol Ester) compressor lubricants are known to cause long term damage to some synthetic roofing materials. Exposure, even if immediately cleaned up, may cause embrittlement (leading to cracking) to occur in one year or more. When performing any service which may risk exposure of compressor oil to the roof, take appropriate precautions to protect roofing. Procedures which risk oil leakage include but are not limited to compressor replacement, repairing refrigerant leaks, replacing refrigerant components such as filter drier, pressure switch, metering device, coil, accumulator, or reversing valve.

Synthetic Roof Precautionary Procedure

1. Cover extended roof working area with an impermeable polyethylene (plastic) drop cloth or tarp. Cover an approximate 10 x 10 ft area.
2. Cover area in front of the unit service panel with a terry cloth shop towel to absorb lubricant spills and prevent run-offs, and protect drop cloth from tears caused by tools or components.
3. Place terry cloth shop towel inside unit immediately under component(s) to be serviced and prevent lubricant run-offs through the louvered openings in the base pan.

4. Perform required service.

5. Remove and dispose of any oil contaminated material per local codes.

Brazing

This section on brazing is not intended to teach a technician how to braze. There are books and classes which teach and refine brazing techniques. The basic points below are listed only as a reminder.

Definition: The joining and sealing of metals using a nonferrous metal having a melting point over 800°F/426.6°C.

Flux: A cleaning solution applied to tubing or wire before it is brazed. Flux improves the strength of the brazed connection.

When brazing is required in the refrigeration system, certain basics should be remembered. The following are a few of the basic rules.

1. Clean joints make the best joints. To clean:
 - Remove all oxidation from surfaces to a shiny finish before brazing.
 - Remove all flux residue with brush and water while material is still hot.
2. Silver brazing alloy is used on copper-to-brass, copper-to-steel, or copper-to-copper. Flux is required when using silver brazing alloy. Do not use low temperature solder.
3. Fluxes should be used carefully. Avoid excessive application and do not allow fluxes to enter into the system.
4. Brazing temperature of copper is proper when it is heated to a minimum temperature of 800°F and it is a dull red color in appearance.

Service Valves and Pumpdown

WARNING

PERSONAL INJURY AND UNIT DAMAGE HAZARD

Failure to follow this warning could result in personal injury or equipment damage.

Never attempt to make repairs to existing service valves. Unit operates under high pressure. Damaged seats and o-rings should not be replaced. Replacement of entire service valve is required. Service valve must be replaced by properly trained service technician.

Service valves provide a means for holding original factory charge in outdoor unit prior to hookup to indoor coil. They also contain gauge ports for measuring system pressures and provide shutoff convenience for certain types of repairs.

The service valve is a front-seating valve, which has a service port that contains a Schrader fitting. The service port is always pressurized after the valve is moved off the front-seat position.

The service valves in the outdoor unit come from the factory front-seated. This means that the refrigerant charge is isolated from the line-set connection ports. The interconnecting tubing (line set) can be brazed to the service valves using industry accepted methods and materials. Consult local codes.

Before brazing the line set to the valve, the belled ends of the sweat connections on the service valves must be cleaned so that no brass plating remains on either the inside or outside of the bell joint. To prevent damage to the valve and/or cap "O" ring, use a wet cloth or other acceptable heat-sinking material on the valve before brazing. To prevent damage to the unit, use a metal barrier between brazing area and unit.

After the brazing operation and the refrigerant tubing and evaporator coil have been evacuated, the valve stem can be turned counterclockwise until back-seats, which releases refrigerant into tubing and evaporator coil. The system can now be operated.

The service valve–stem cap is tightened to 20 ± 2 ft/lb torque and the service–port caps to 9 ± 2 ft/lb torque. The seating surface of the valve stem has a knife–set edge against which the caps are tightened to attain a metal–to–metal seal.

The service valve cannot be field repaired; therefore, only a complete valve or valve stem and service–port caps are available for replacement.

If the service valve is to be replaced, a metal barrier must be inserted between the valve and the unit to prevent damaging the unit exterior from the heat of the brazing operations.

CAUTION

PERSONAL INJURY HAZARD

Failure to follow this caution may result in personal injury.

Wear safety glasses, protective clothing, and gloves when handling refrigerant.

Pumpdown & Evacuation

CAUTION

ENVIRONMENTAL HAZARD

Failure to follow this caution may result in environmental damage.

Federal regulations require that you do not vent refrigerant to the atmosphere. Recover during system repair or final unit disposal.

If this system requires either a Pump Down or Evacuation for any reason, the procedures below must be followed:

Pump Down - Infinity Communicating - 25VNA8

Because this system is inverter controlled, compressor, suction pressure transducer and EXV, conventional procedure cannot be used to “pump down” and isolate the refrigerant into the outdoor unit. The UI (User Interface) has provisions to assist in performing this function.

1. Connect gauges to 25VNA8 liquid and vapor service valve ports to monitor operating pressures during and at completion of the procedure.
2. In the advanced menu of the UI, go to Checkout > Heat Pump> Pumpdown
3. Select mode to pump down in (COOL or HEAT), COOL mode allows refrigerant to be isolated in outdoor unit. HEAT mode allows the refrigerant to be isolated in indoor coil and lineset. Set desired time period. Default time period for the procedure is 120 minutes.
4. Select Start on UI to begin the pump–down process. Unit will begin running in selected mode after a brief delay.
5. Close the liquid service valve.
6. The unit will run in selected mode with the low pressure protection set to indicate pump–down is complete when the suction pressure drops below 10 psig. Compressor protections are still active to prevent damage to the compressor or inverter (high pressure, high current, high torque, etc.) .
7. Once system indicates pump–down complete or failure to complete shutdown, close vapor service valve.
8. A small quantity of charge will remain in isolated section of system dependent on ambient temperature and overall system charge. This charge must be manually recovered. A recovery system will be required to remove final quantity of refrigerant from indoor coil and line set.
9. Remove power from indoor and heat pump unit prior to servicing unit.

Pump Down - Infinity Communicating - 24VNA9

Because this system is inverter controlled, compressor, suction pressure transducer, conventional procedure cannot be used to “pump down” and isolate the refrigerant into the outdoor unit. The UI (User Interface) has provisions to assist in performing this function.

1. Connect gauges to 24VNA9 liquid and vapor service valve ports to monitor operating pressures during and at completion of the procedure.
2. In the advanced menu of the UI, go to Checkout > Pump–down
3. Select mode to pump down in (COOL). Set desired time period. Default time period for the procedure is 120 minutes.
4. Select Start on UI to begin the pump–down process. Unit will begin running in selected mode after a brief delay.
5. Close the liquid service valve.
6. The unit will run in selected mode with the low pressure protection set to indicate pump–down is complete when the suction pressure drops below 10 psig. Compressor protections are still active to prevent damage to the compressor or inverter (high pressure, high current, high torque, etc.) .
7. Once system indicates pump–down complete or failure to complete shutdown, close vapor service valve.
8. A small quantity of charge will remain in isolated section of system dependent on ambient temperature and overall system charge. This charge must be manually recovered. A recovery system will be required to remove final quantity of refrigerant from indoor coil and line set.
9. Remove power from indoor and outdoor unit prior to servicing unit.

Pump Down – Using 2–stg HP Tstat - 25VNA8 (Non-Communicating)

Because this system has an inverter controlled compressor, suction pressure transducer and EXV, conventional procedure cannot be used to “pump down” and isolate the refrigerant into the outdoor unit.

1. Connect gauges to 25VNA8 liquid and vapor service valve ports to monitor operating pressures during and at completion of the procedure.
2. Force system to operate in high stage by creating a large differential between room temperature and set point on thermostat. Use multi–meter to verify that 24 VAC is present between C and Y1 and Y2 terminals at outdoor unit.
3. Close the liquid service valve.
4. The unit will continue to run until high or low pressure switches open. Close vapor service valve once compressor shuts down.
5. Remove power from indoor and heat pump unit prior to servicing unit.
6. A quantity of charge will remain in isolated section of system dependent on ambient temperature and overall system charge. This charge must be manually recovered. A recovery system will be required to remove final quantity of refrigerant from indoor coil and line set.

Pump Down – Using 2–stg Tstat - 24VNA9 (Non-Communicating)

Because this system has an inverter controlled compressor, suction pressure transducer, conventional procedure cannot be used to “pump down” and isolate the refrigerant into the outdoor unit.

1. Connect gauges to 24VNA9 liquid and vapor service valve ports to monitor operating pressures during and at completion of the procedure.
2. Force system to operate in high stage by creating a large differential between room temperature and set point on thermostat. Use multi–meter to verify that 24 VAC is present between C and Y1 and Y2 terminals at outdoor unit.

3. Close the liquid service valve.
4. The unit will continue to run until high or low pressure switches open. Close vapor service valve once compressor shuts down.
5. Remove power from indoor and outdoor unit prior to servicing unit.
6. A quantity of charge will remain in isolated section of system dependent on ambient temperature and overall system charge. This charge must be manually recovered. A recovery system will be required to remove final quantity of refrigerant from indoor coil and line set.

Evacuation and recovery of refrigerant from 25VNA8

Because this system has an EXV for the heating expansion device, additional steps may be taken to open the EXV for fastest refrigerant recovery and evacuation. If the EXV is not open when pulling a vacuum or recovering refrigerant from the heat pump unit, extended evacuation time may be required and/or inadequate vacuum obtained. The UI (User Interface) has provisions to open the EXV for refrigerant recovery and/or evacuation.

1. Connect gauges to 25VNA8 liquid and vapor service valve ports to monitor operating pressures during and at completion of the procedure. Attach recovery system or vacuum pump to gauge set as needed for the service procedure. The service valves must be open to evacuate the unit through the line set service ports. The suction capillary service port is a direct connection to the suction port of the compressor and may also be used.
2. In the advanced menu of the UI, go to Checkout > Heat Pump > Evacuation.
3. Set desired time period. Default time period for the procedure is 120 minutes.
4. Select START on UI to open the valve.
5. Begin evacuation or refrigerant recovery as required for the procedure after UI indicates the EXV is open. Power may be removed from heat pump after the UI indicates "READY TO EVACUATE."
6. Remove power from indoor and heat pump unit prior to servicing unit. The EXV will retain the open position.

NOTE: See service training materials for troubleshooting the EXV using EXV CHECK mode.

Evacuation and recovery of refrigerant from 25VNA8 when using non-communicating thermostat

Refrigerant recovery and evacuation can be performed without a UI (User Interface) but will take more time. If EXV is not forced open the recovery and evacuation must rely on check valve as a bypass.

1. Connect gauges to 25VNA8 liquid and vapor service valve ports to monitor operating pressures during and at completion of the procedure. Attach recovery system or vacuum pump to gauge set as needed for the service procedure. The service valves must be open to evacuate the unit through the line set service ports. The suction capillary service port is a direct connection to the suction port of the compressor and may also be used.
2. Begin evacuation or refrigerant. Allow extra time for refrigerant recovery and establishing a thorough evacuation.

Evacuation and recovery of refrigerant from 24VNA9

1. Connect gauges to 24VNA9 liquid and vapor service valve ports to monitor operating pressures during and at completion of the procedure. Attach recovery system or vacuum pump to gauge set as needed for the service procedure. The service valves must be open to evacuate the unit through the line set service ports.

Evacuation and recovery of refrigerant from 24VNA9 when using non-communicating thermostat

1. Connect gauges to 24VNA9 liquid and vapor service valve ports to monitor operating pressures during and at completion of the procedure. Attach recovery system or vacuum pump to gauge set as needed for the service procedure. The service valves must be open to evacuate the unit through the line set service ports.

Reversing Valve

In heat pumps, changeover between heating and cooling modes is accomplished with a valve that reverses flow of refrigerant in system. This reversing valve device is easy to troubleshoot and replace. The reversing valve solenoid can be checked with power off with an ohmmeter. Check for continuity and shorting to ground. With control circuit (24v) power on, check for correct voltage at solenoid coil. Check for overheated solenoid.

With unit operating, other items can be checked, such as frost or condensate water on refrigerant lines.

The sound made by a reversing valve as it begins or ends defrost is a "whooshing" sound, as the valve reverses and pressures in system equalize. An experienced service technician detects this sound and uses it as a valuable troubleshooting tool.

Using a remote measuring device, check inlet and outlet line temperatures. **DO NOT** touch lines. If reversing valve is operating normally, inlet and outlet temperatures on appropriate lines should be close to each other. Any difference would be due to heat loss or gain across valve body. Temperatures are best checked with a remote reading electronic-type thermometer with multiple probes. Route thermocouple leads to inside of coil area through service valve mounting plate area underneath coil. Fig. 48 and Fig. 49 show test points (TP) on reversing valve for recording temperatures. Insulate points for more accurate reading.

If valve is defective:

1. Shut off all power to unit and remove charge from system.
2. Remove solenoid coil from valve body. Remove valve by cutting it from system with tubing cutter. Repair person should cut in such a way that stubs can be easily re-brazed back into system. Do not use hacksaw. This introduces chips into system that cause failure. After defective valve is removed, wrap it in wet rag and carefully unbrazed stubs. Save stubs for future use. Because defective valve is not overheated, it can be analyzed for cause of failure when it is returned.
3. Braze new valve onto used stubs. Keep stubs oriented correctly. Scratch corresponding matching marks on old valve and stubs and on new valve body to aid in lining up new valve properly. When brazing stubs into valve, protect valve body with wet rag to prevent overheating.
4. Use slip couplings to install new valve with stubs back into system. Even if stubs are long, wrap valve with a wet rag to prevent overheating.
5. After valve is brazed in, check for leaks. Evacuate and charge system. Operate system in both modes several times to be sure valve functions properly.

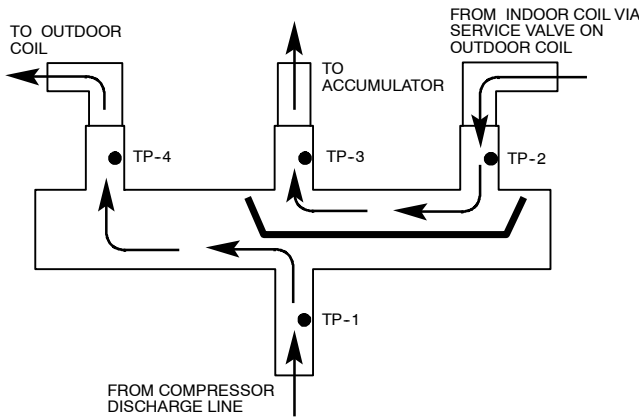

A88342

Fig. 48 – Reversing Valve
(Cooling Mode or Defrost Mode, Solenoid Energized)

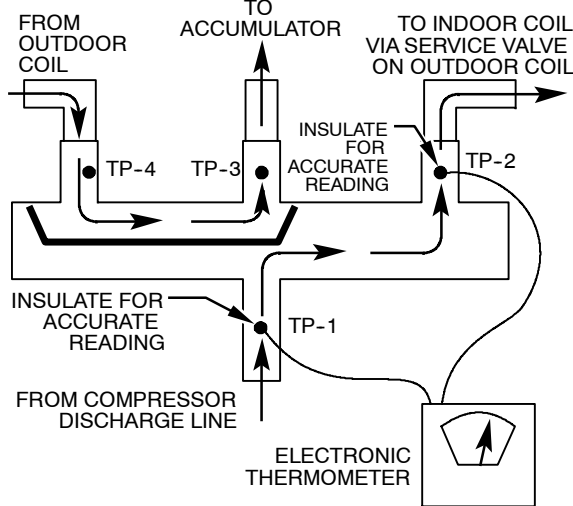

A88341

Fig. 49 – Reversing Valve
(Heating Mode, Solenoid De-Energized)

Liquid Line Filter Drier

Filter driers are specifically designed for R-22 or Puron® refrigerant. Only operate with the appropriate drier using factory authorized components.

It is recommended that the liquid line drier be installed at the indoor unit. Placing the drier near the TXV allows additional protection to the TXV as the liquid line drier also acts as a strainer.

⚠ CAUTION

UNIT DAMAGE HAZARD

Failure to follow this caution may result in equipment damage or improper operation.

To avoid performance loss and compressor failure, installation of filter drier in liquid line is required.

⚠ CAUTION

UNIT DAMAGE HAZARD

Failure to follow this caution may result in equipment damage or improper operation.

To avoid filter drier damage while brazing, filter drier must be wrapped in a heat-sinking material such as a wet cloth.

Install Liquid-line Filter Drier Indoor

Install filter drier as follows:

1. Braze 5 in. liquid tube to the indoor coil.
2. Wrap filter drier with damp cloth.
3. Braze filter drier to 5 in. long liquid tube from step 1.
4. Connect and braze liquid refrigerant tube to the filter drier.

Suction Line Filter Drier

The suction line drier is specifically designed to operate with Puron®, use only factory authorized components. Suction line filter drier is used in cases where acid might occur, such as burnout. Heat pump units must have the drier installed between the compressor and accumulator only. Remove after 10 hours of operation. Never leave suction line filter drier in a system longer than 72 hours (actual time).

Thermostatic Expansion Valve (TXV)

All fan coils and furnace coils will have a factory installed thermostatic expansion valve (TXV). The TXV will be a bi-flow, hard-shutoff with an external equalizer and a balance port pin. A hard shut-off TXV does not have a bleed port. Therefore, minimal equalization takes place after shutdown. TXVs are specifically designed to operate with Puron® or R-22 refrigerant, use only factory authorized TXV's. **Do not interchange Puron and R-22 TXVs.**

TXV Operation

The TXV is a metering device that is used in air conditioning and heat pump systems to adjust to changing load conditions by maintaining a preset superheat temperature at the outlet of the evaporator coil. The volume of refrigerant metered through the valve seat is dependent upon the following:

1. Superheat temperature is sensed by cap tube sensing bulb on suction tube at outlet of evaporator coil. This temperature is converted into pressure by refrigerant in the bulb pushing downward on the diaphragm which opens the valve via the push rods.
2. The suction pressure at the outlet of the evaporator coil is transferred via the external equalizer tube to the underside of the diaphragm. This is needed to account for the indoor coil pressure drop. Residential coils typically have a high pressure drop, which requires this valve feature.
3. The pin is spring loaded, which exerts pressure on the underside of the diaphragm. Therefore, the bulb pressure works against the spring pressure and evaporator suction pressure to open the valve.

If the load increases, the temperature increases at the bulb, which increases the pressure on the top side of the diaphragm. This opens the valve and increases the flow of refrigerant. The increased refrigerant flow causes the leaving evaporator temperature to decrease. This lowers the pressure on the diaphragm and closes the pin. The refrigerant flow is effectively stabilized to the load demand with negligible change in superheat.

Accumulator

The accumulator is specifically designed to operate with Puron® or R22 respectfully; use only factory-authorized components. Under some light load conditions on indoor coils, liquid refrigerant is present in suction gas returning to compressor. The accumulator stores liquid and allows it to boil off into a vapor so it can be safely returned to compressor. Since a compressor is designed to pump refrigerant in its gaseous state, introduction of liquid into it could cause severe damage or total failure of compressor.

The accumulator is a passive device which seldom needs replacing. Occasionally its internal oil return orifice or bleed hole may become plugged. Some oil is contained in refrigerant returning to compressor. It cannot boil off in accumulator with liquid refrigerant. The bleed hole allows a small amount of oil and refrigerant to enter the return line where velocity of refrigerant returns it to compressor. If bleed hole plugs, oil is trapped in accumulator, and compressor will eventually fail from lack of lubrication. If bleed hole is plugged, accumulator must be changed. The accumulator has a fusible element located in the bottom end bell. (See Fig. 50.) This fusible element will melt at 430°F/221°C and vent the refrigerant if this temperature is reached either internal or external to the system. If fuse melts, the accumulator must be replaced.

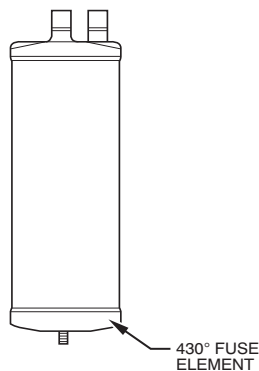

Fig. 50 – Accumulator

A88410

To change accumulator:

1. Shut off all power to unit.
2. Recover all refrigerant from system.
3. Break vacuum with dry nitrogen. Do not exceed 5 psig.

NOTE: Coil may be removed for access to accumulator. Refer to appropriate sections of Service Manual for instructions.

CAUTION

PERSONAL INJURY HAZARD

Failure to follow this caution may result in personal injury.

Wear safety glasses, protective clothing, and gloves when handling refrigerant.

4. Remove accumulator from system with tubing cutter.
5. Tape ends of open tubing.
6. Scratch matching marks on tubing studs and old accumulator. Scratch matching marks on new accumulator. Unbraid stubs from old accumulator and braid into new accumulator.
7. Thoroughly rinse any flux residue from joints and paint with corrosion-resistant coating such as zinc-rich paint.
8. Install factory authorized accumulator into system with copper slip couplings.
9. Evacuate and charge system.

Pour and measure oil quantity (if any) from old accumulator. If more than 20 percent of oil charge is trapped in accumulator, add new POE oil to compressor to make up for this loss.



WARNING

ELECTRICAL SHOCK HAZARD

Failure to follow this warning could result in personal injury or death.

Before installing, modifying, or servicing system, main electrical disconnect switch must be in the OFF position. There may be more than 1 disconnect switch. Lock out and tag switch with a suitable warning label.

REFRIGERATION SYSTEM REPAIR

Leak Detection

New installations should be checked for leaks prior to complete charging. If a system has lost all or most of its charge, system must be pressurized again to approximately 150 psi minimum and 375 psi maximum. This can be done by adding refrigerant using normal charging procedures or by pressurizing system with nitrogen (less expensive than refrigerant). Nitrogen also leaks faster than refrigerants. Nitrogen cannot, however, be detected by an electronic leak detector. (See Fig. 51.)

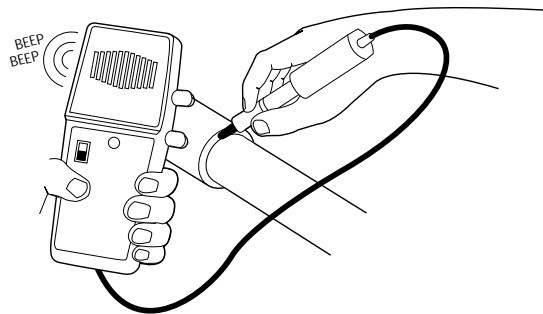

A95422

Fig. 51 – Electronic Leak Detection



WARNING

PERSONAL INJURY AND UNIT DAMAGE HAZARD

Failure to follow this warning could result in personal injury or death.

Due to the high pressure of nitrogen, it should never be used without a pressure regulator on the tank.

Assuming that a system is pressurized with either all refrigerant or a mixture of nitrogen and refrigerant, leaks in the system can be found with an electronic leak detector that is capable of detecting specific refrigerants.

If system has been operating for some time, first check for a leak visually. Since refrigerant carries a small quantity of oil, traces of oil at any joint or connection is an indication that refrigerant is leaking at that point.

A simple and inexpensive method of testing for leaks is to use soap bubbles. (See Fig. 52.) Any solution of water and soap may be used. Soap solution is applied to all joints and connections in system. A small pinhole leak is located by tracing bubbles in soap solution around leak. If the leak is very small, several minutes may pass before a bubble will form. Popular commercial leak detection solutions give better, longer-lasting bubbles and more accurate results than plain soapy water. The bubble solution must be removed from the tubing and fittings after checking for leaks as some solutions may corrode the metal.

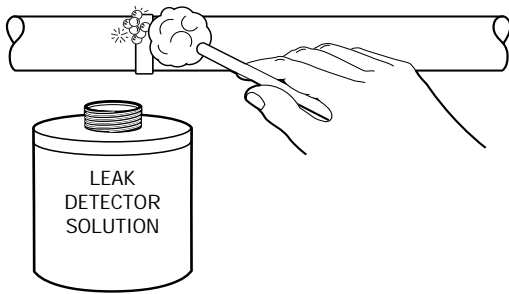

Fig. 52 – Bubble Leak Detection

A95423

You may use an electronic leak detector designed for specific refrigerant to check for leaks. (See Fig. 51.) This unquestionably is the most efficient and easiest method for checking leaks. There are various types of electronic leak detectors. Check with manufacturer of equipment for suitability. Generally speaking, they are portable, lightweight, and consist of a box with several switches and a probe or sniffer. Detector is turned on and probe is passed around all fittings and connections in system. Leak is detected by either the movement of a pointer on detector dial, a buzzing sound, or a light. In all instances when a leak is found, system charge must be recovered and leak repaired before final charging and operation. After leak testing or leak is repaired, replace liquid line filter drier, evacuate system, and recharge with correct refrigerant quantity.



WARNING

ELECTRICAL SHOCK HAZARD

Failure to follow this warning could result in personal injury or death.

Before installing, modifying, or servicing system, main electrical disconnect switch must be in the OFF position. There may be more than 1 disconnect switch. Lock out and tag switch with a suitable warning label.

Coil Removal

Coils are easy to remove if required for compressor removal, or to replace coil.

1. Shut off all power to unit.
2. Recover refrigerant from system through service valves.
3. Break vacuum with nitrogen.
4. Remove top cover.
5. Remove screws in base pan to coil grille.
6. Remove coil grille from unit.
7. Remove screws on corner post holding coil tube sheet.



WARNING

FIRE HAZARD

Failure to follow this warning could result in personal injury or equipment damage.

Cut tubing to reduce possibility of personal injury and fire.

8. Use midget tubing cutter to cut liquid and vapor lines at both sides of coil. Cut in convenient location for easy reassembly with copper slip couplings.
9. Lift coil vertically from basepan and carefully place aside.
10. Reverse procedure to reinstall coil.
11. Replace filter drier, evacuate system, recharge, and check for normal systems operation.